

CHRYSLER

1936



*Airflow*





THE AIRFLOW

*Chrysler Imperial*

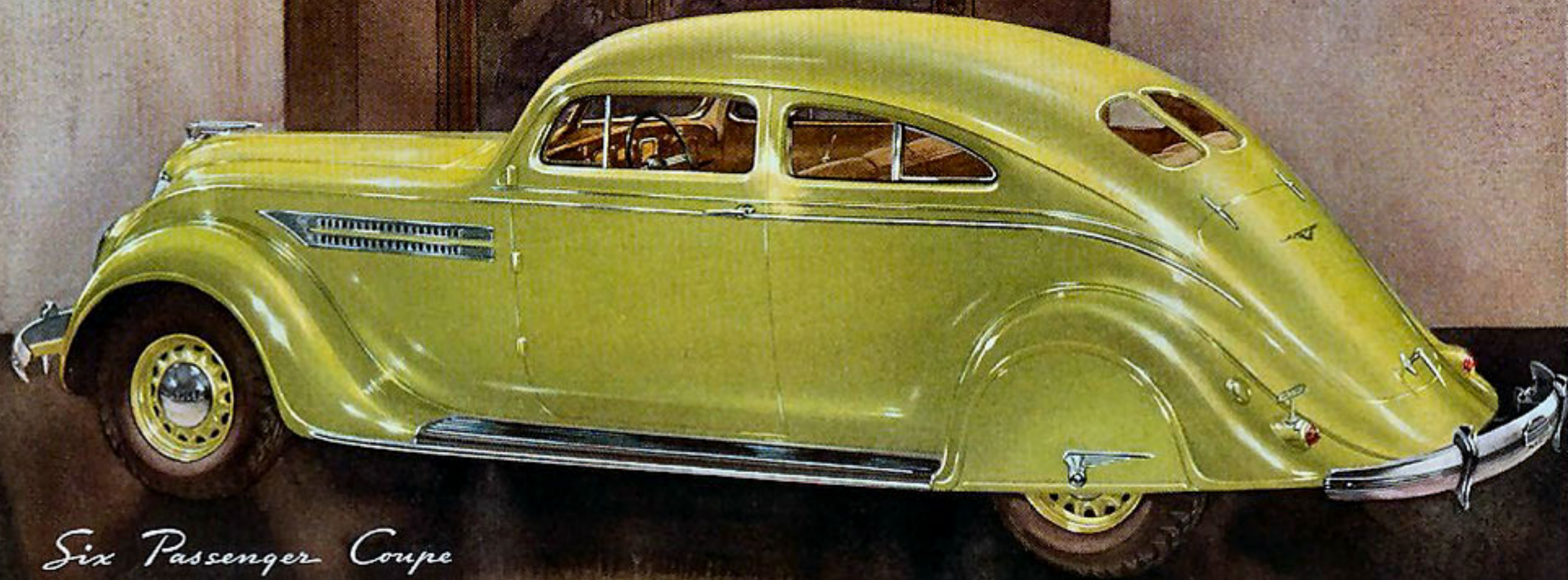

*Six Passenger Coupe*



# AIRFLOW LUXURY



*T*O ACTUALLY drive the 1936 Chrysler Airflow is to experience a new and thrilling sense of complete satisfaction. There is a definite realization that you are driving the finest of motor cars. One need not be an expert to judge the qualities that distinguish the Chrysler Airflow. Its points are unmistakable and they blend so naturally in the ensemble that one instinctively recognizes it as the product of master engineers and craftsmen.



Built-in trunks of the Four-Door Sedans and the rear luggage compartments of other models are surprisingly capacious.



Ash receivers with snap lids are accessibly located in the forward end of the recessed rear seat arm rests.



Smoothly operating cranks, within easy reach of the driver, control the ribbon-wind ventilating windshields.



Large glove and parcel compartments, one with a lock, are at either end of the beautifully grained new instrument panel.





THE AIRFLOW  
*Chrysler Imperial*

*Six Passenger Sedan*



THE AIRFLOW

*Chrysler Eight*

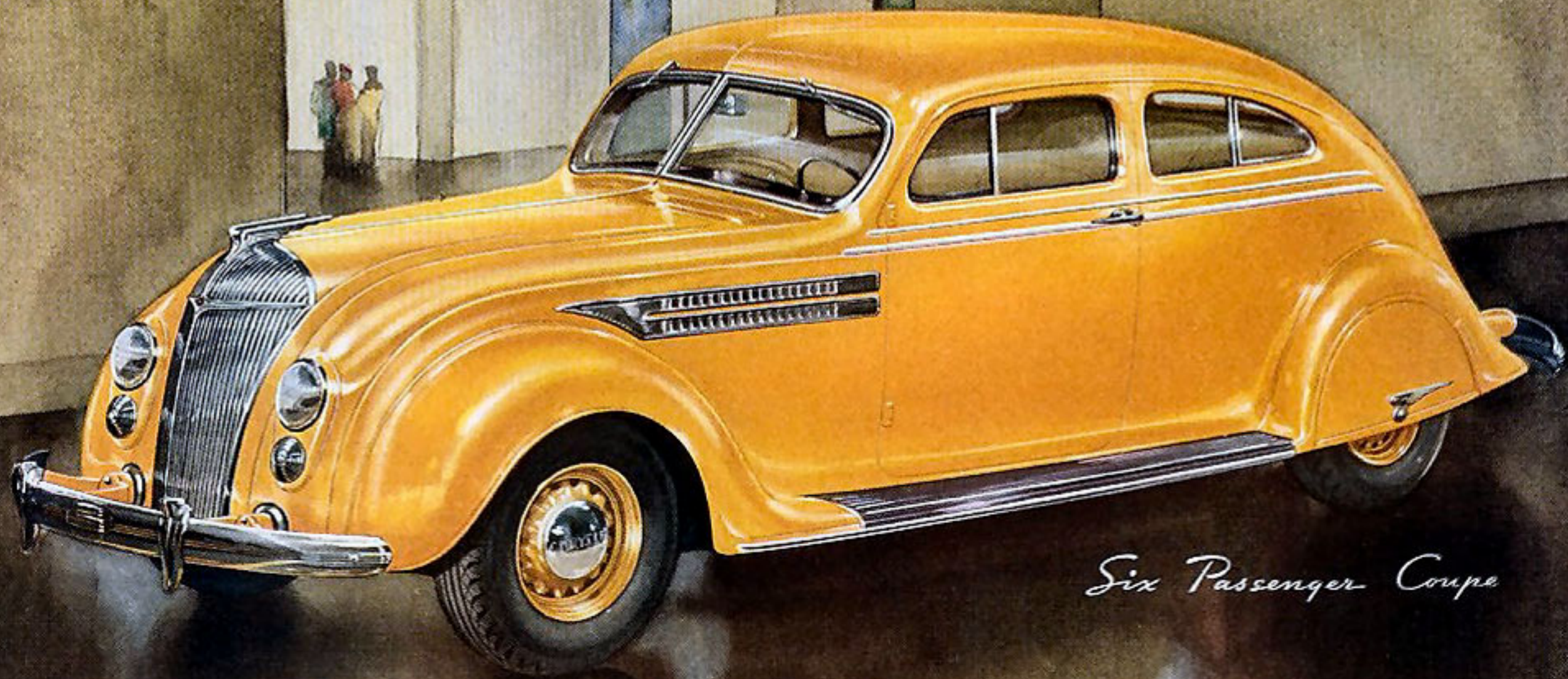

*Six Passenger Coupe*



THE AIRFLOW

*Chrysler Eight*

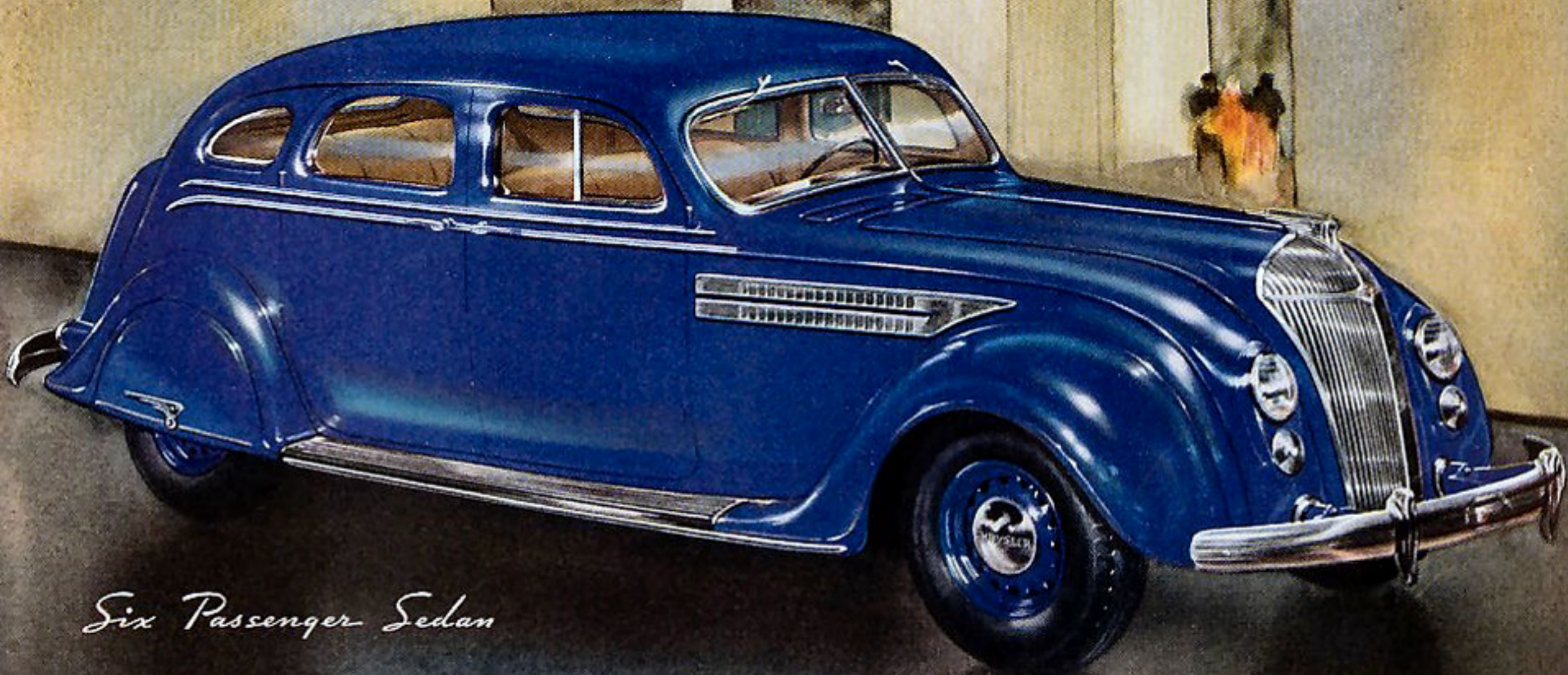

*Six Passenger Sedan*



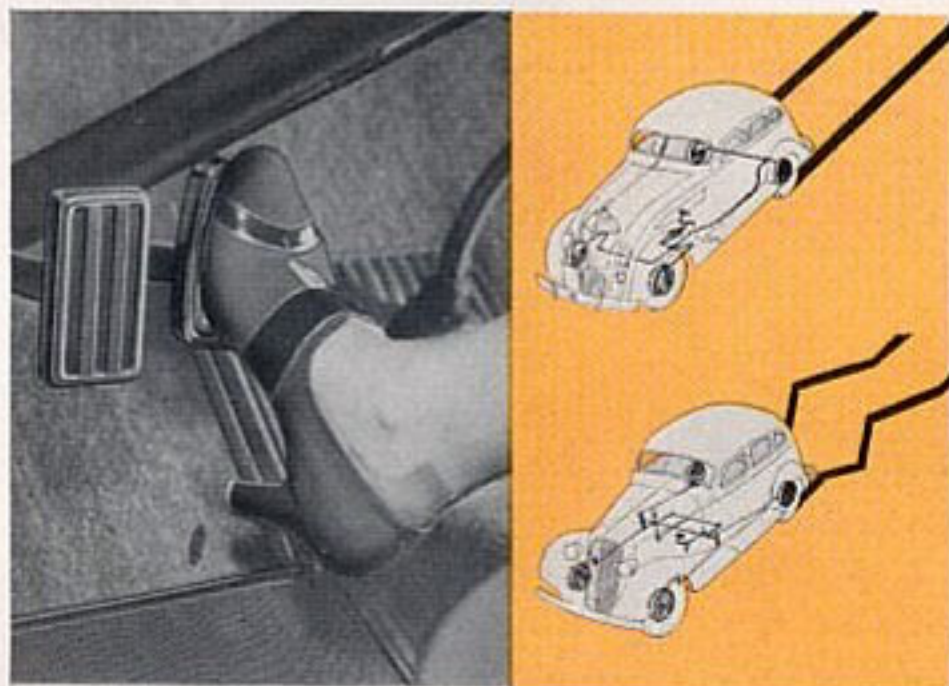
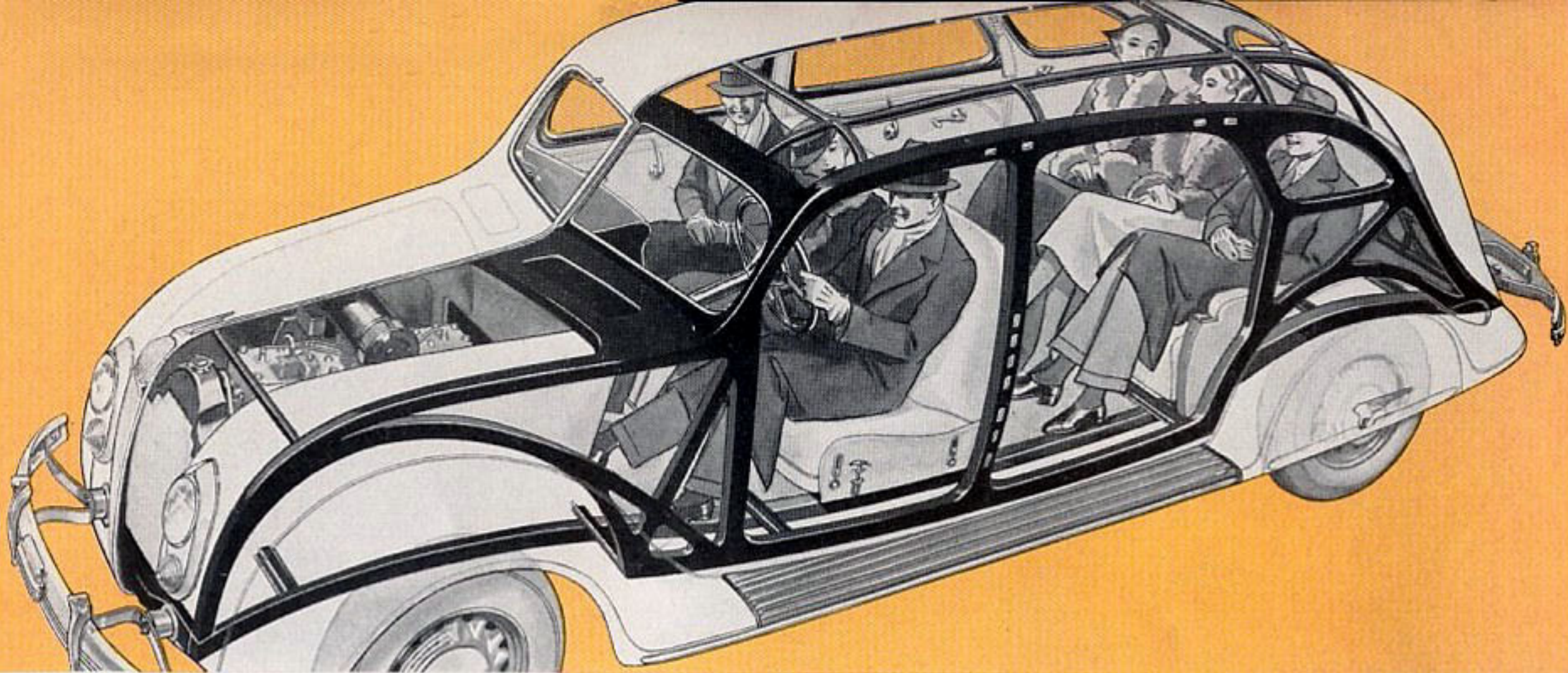

Jerky stops are unknown with Airflow hydraulic brakes. The driver is always in control. A soft pedal pressure exerts tremendous braking force.

*A*IRFLOW design permits the safest type of construction ever embodied in any motor car. No conventionally designed car can compare in strength and rigidity with the Airflow. Likened to a modern cantilever bridge, the Airflow unit body and frame have accomplished the same result as that of bridge girders and trusses. Passengers sit inside the solid steel framework, surrounded at the ends, sides, top and bottom by steel girders and panels of great structural strength. The Airflow body extends in unbroken girders of steel from front to rear. Airflow body side panels are higher, giving added protection while providing unrestricted vision for driver and passengers.





*The soft, restful, pillow-like center arm rest in Airflow rear seats is extremely wide, providing unusual comfort and precluding elbow interference. It folds neatly into the back when three ride in the seat.*

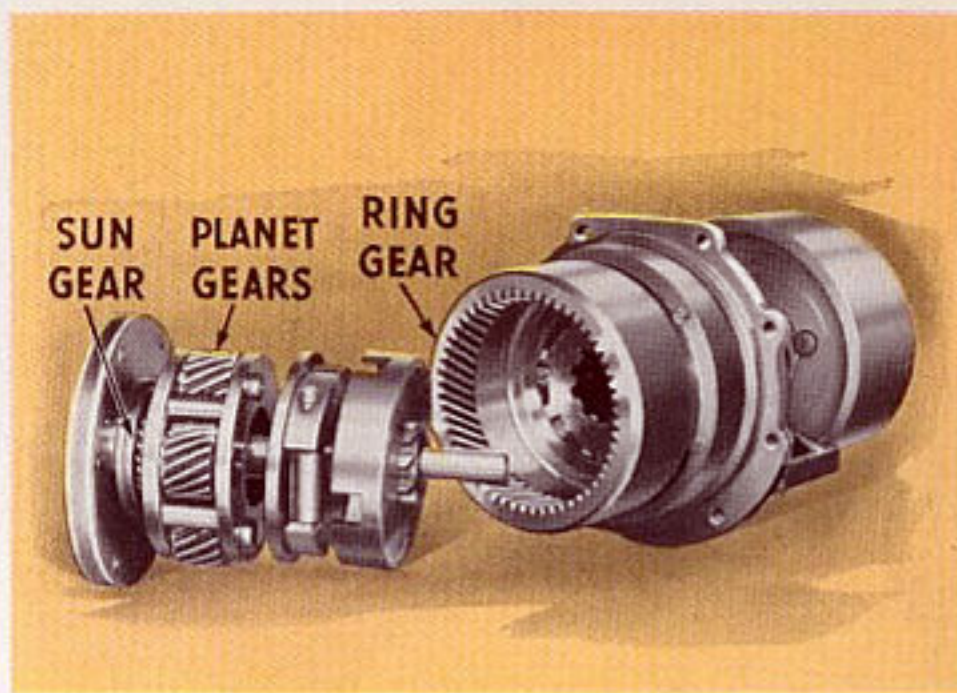

*The automatic overdrive, with quiet, helical planet gears that revolve around the sun gear and engage the ring gear, permits high road speeds while reducing engine speed and effort one-third. It greatly increases fuel mileage.*



The simplified ventilating system includes outward-swinging rear quarter windows operated by a convenient thumbscrew.



The headlamps are recessed into modernistic panels with the horn cover grilles, enhancing the sweeping new hood design.

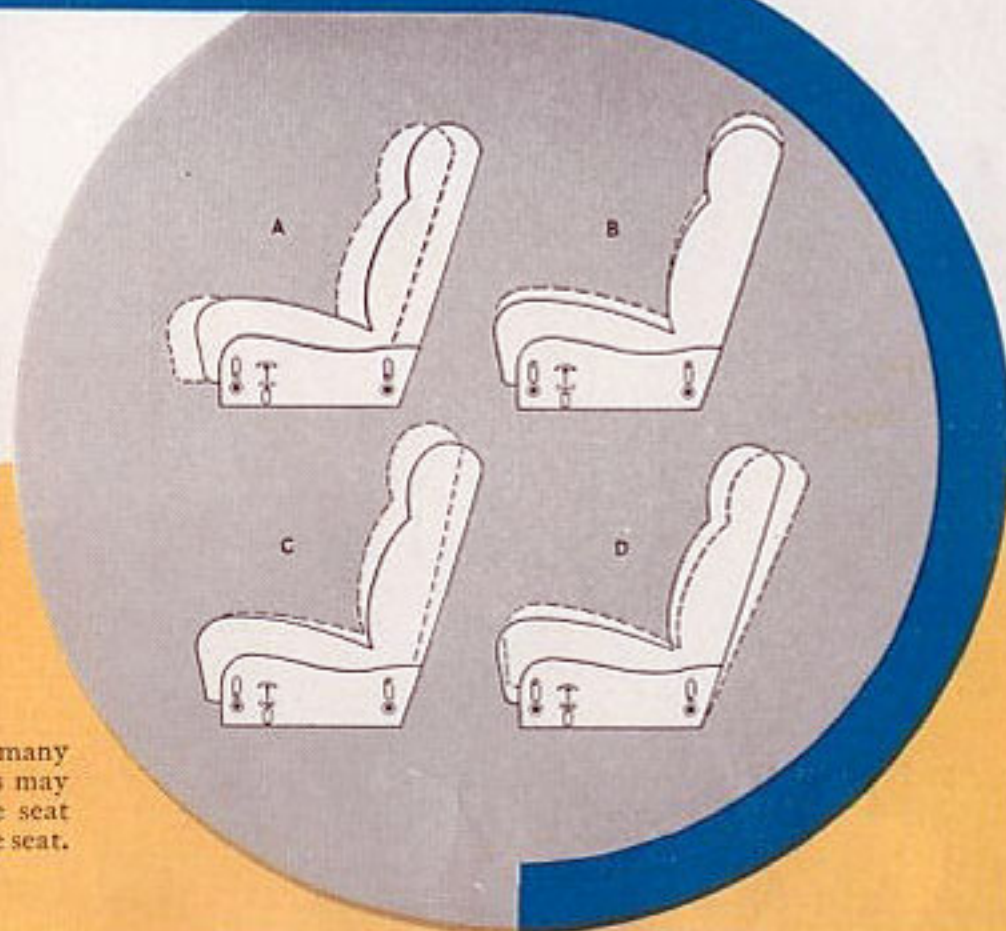

The dotted lines, A, B, C and D show the many positions to which the new Airflow front seats may be adjusted. The mechanism for altering the seat position is conveniently located at the left of the seat.



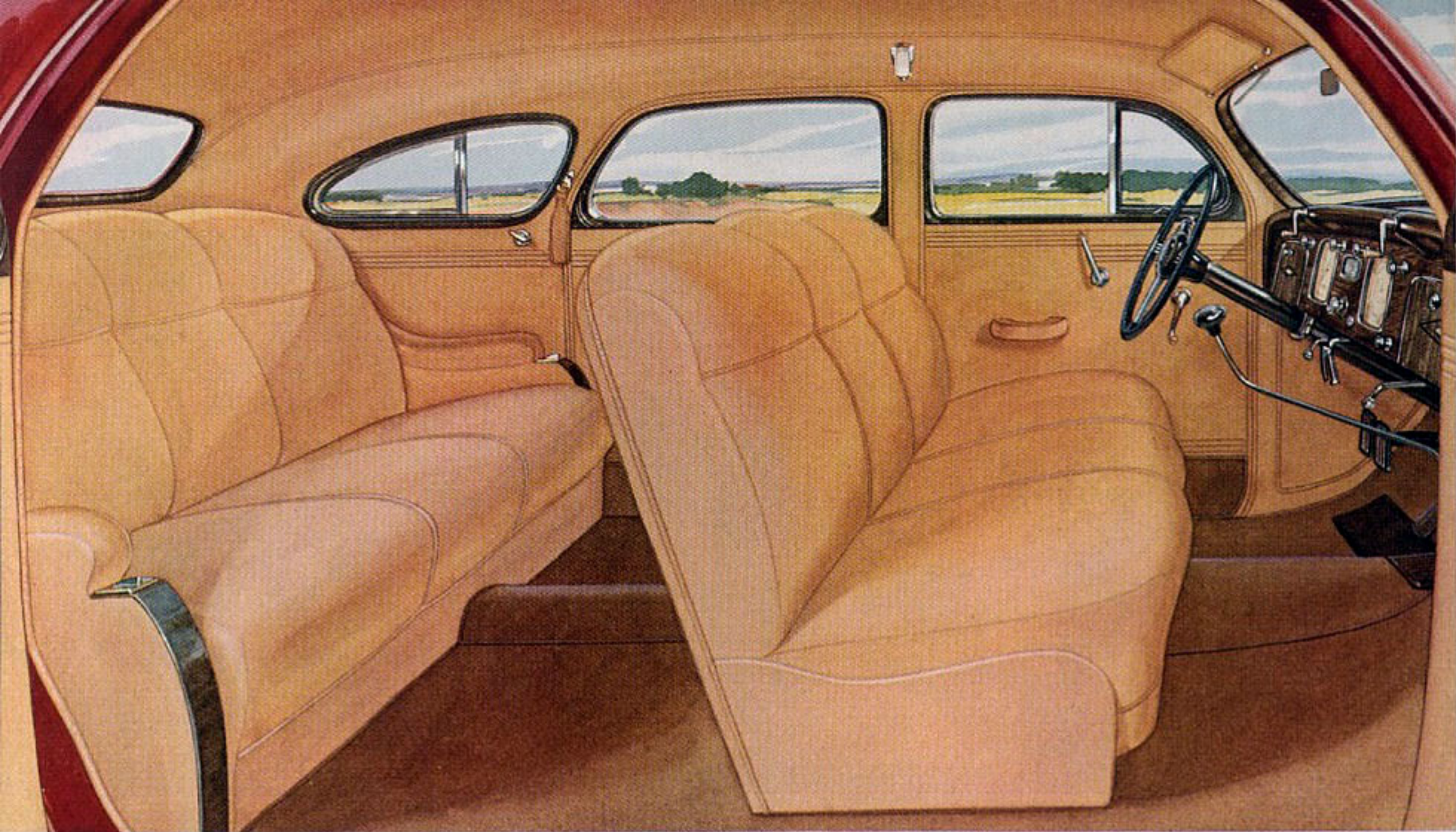

Interior of the Chrysler Imperial Four-Door Sedan.

Interior of the Chrysler Imperial Six Passenger Coupe.

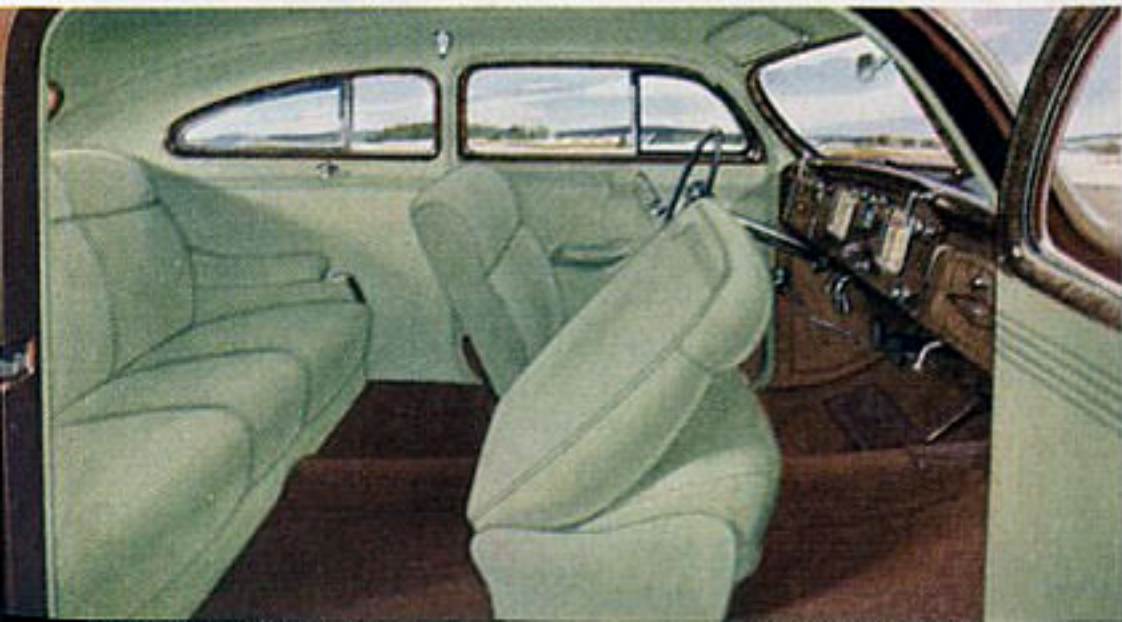

*T*HE wider Airflow front seats, permitting three to ride in comfort, are now fully adjustable in all directions. The rakish angle of the steering wheel makes Airflow driving easier and clears the driving vision. The complete and convenient instrument panel is an outstanding example of decorative art. Rear seats, also wider than in conventional cars, allow plenty of room for relaxation and comfort. Head room in all models is greater than the average. Leg-room is generous in both compartments.



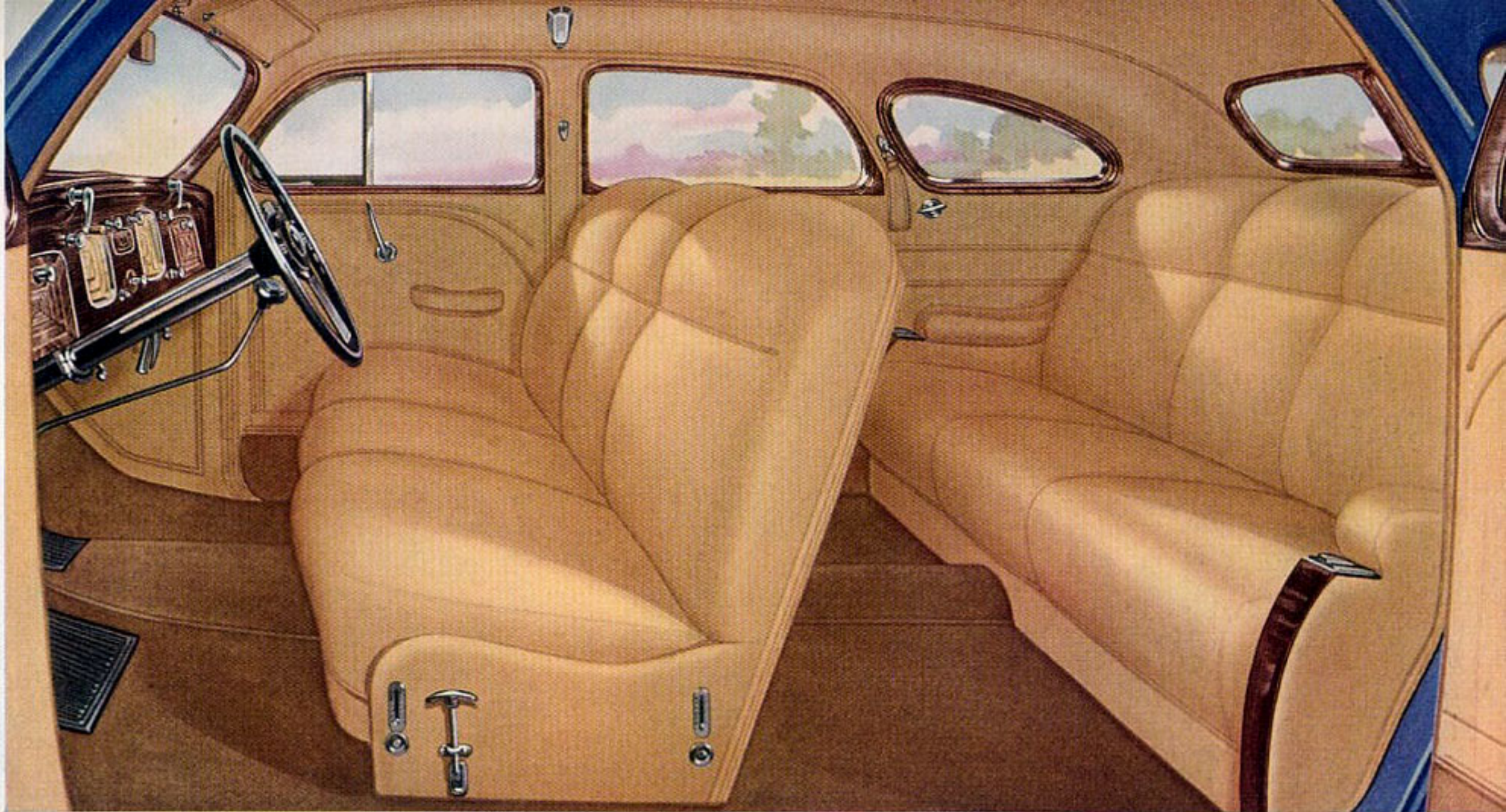

Interior of the Chrysler Airflow Eight Four-Door Sedan.

LUXURY, comfort, smartness and style combine to make the interiors of all Chrysler Airflow models really triumphant achievements in which all that is artistic and beautiful is joined in perfect union with the practical and useful. Upholstery and trim materials are of the finest quality, tailored in the latest and most intriguing fashion. In the wide, deep, chair-height seats and in every detail of interior trim, even to the inside door panels, the handiwork

of the master decorator is evident. The metalware is distinctive. Tenite escutcheon plates enrich the door handles and window controls. The instrument panels and all mouldings are beautifully grained. Reading lights with switches are located on the pillar post. Sedan models have, in addition, an automatic, door-operated light switch. Smartly tailored assist cords are convenient to the rear seat. In all models convenience is predominant.



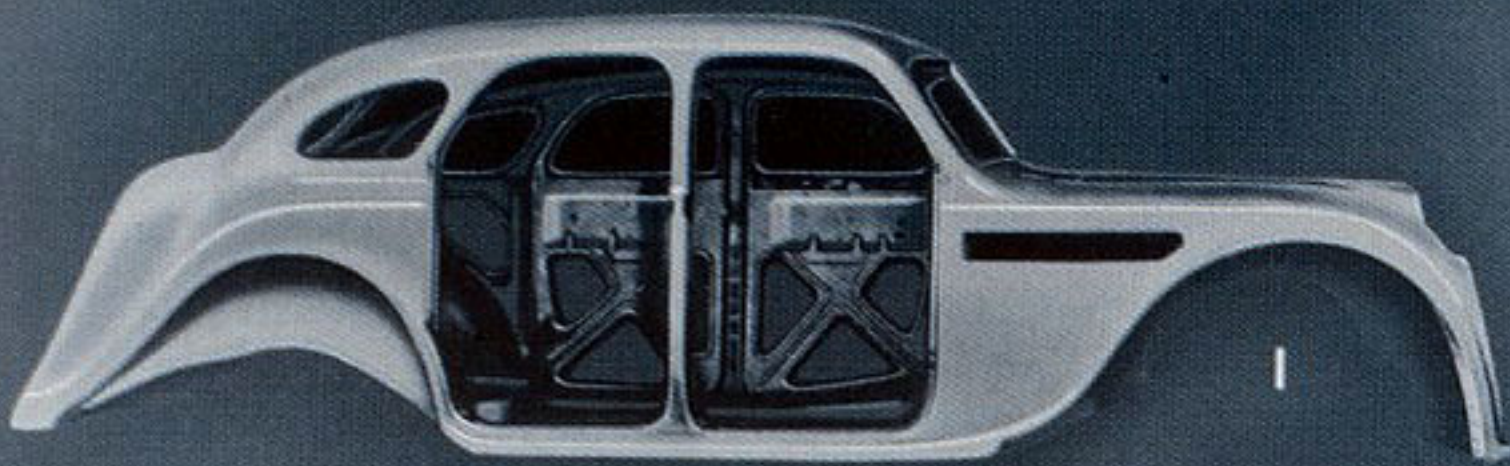

**1** Beneath the exquisitely contoured surface and the luxuriously fashioned interior of the Chrysler Airflow is safe, rigidly braced steel so trussed and welded that the body, the frame and the panels become a solid steel unit of tremendous strength. Gruelling tests and two full years of service in the hands of thousands of Airflow owners have proved Airflow superiority.

**2** Roller bearings instead of bushings are used in Airflow universal joints. They are packed with grease and seldom, if ever, need further lubrication. These universal joints are notably long-lived and trouble-free.

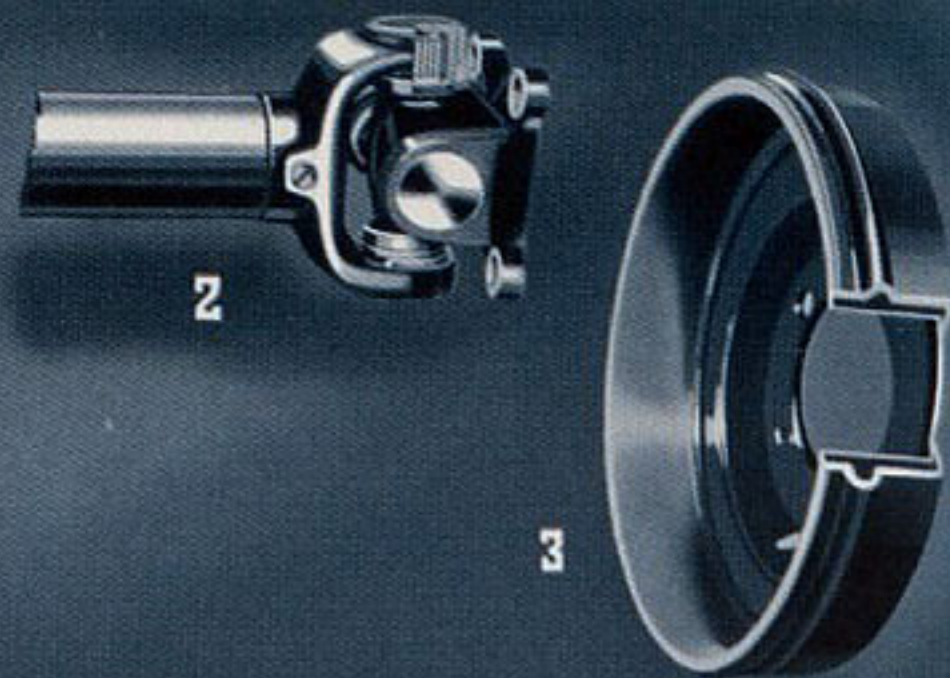

**3** Centrifuge brake drums of steel, lined with centrifugally fused cast iron, do not score easily, are not subject to distortion and, consequently, retard brake lining wear.

**4** Double-acting, adjustable shock absorbers contribute to the Airflow Floating Ride.

**5** Even a novice can shift gears silently and smoothly with the Airflow Synchro-Silent transmission.

**6** The automatic overdrive, marvel of modern motoring, permits high car speeds while reducing engine speed and effort one-third, and greatly increasing fuel economy.

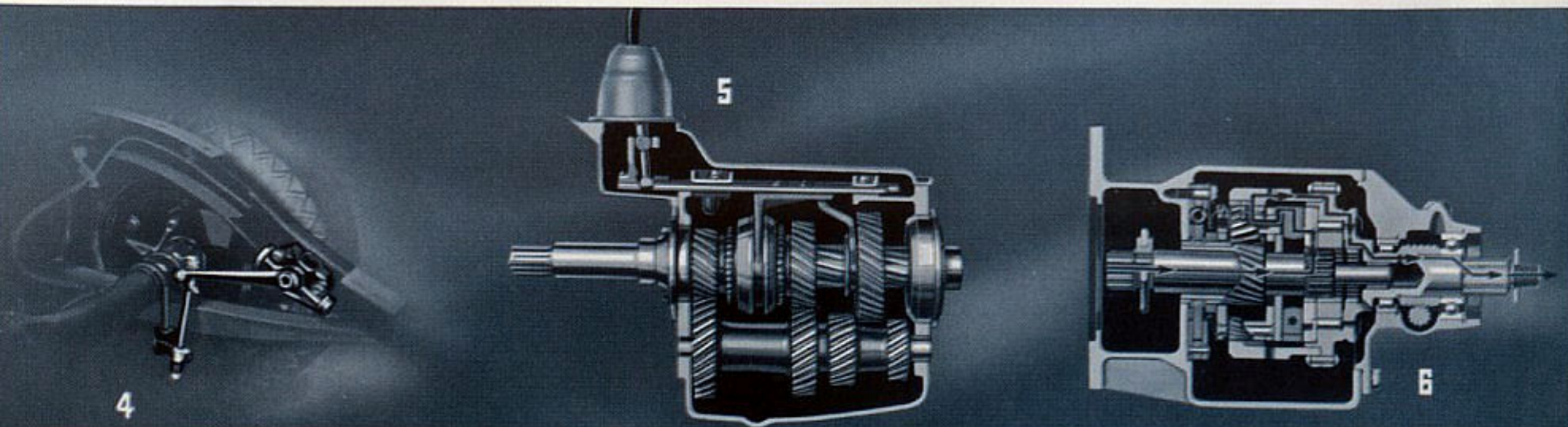



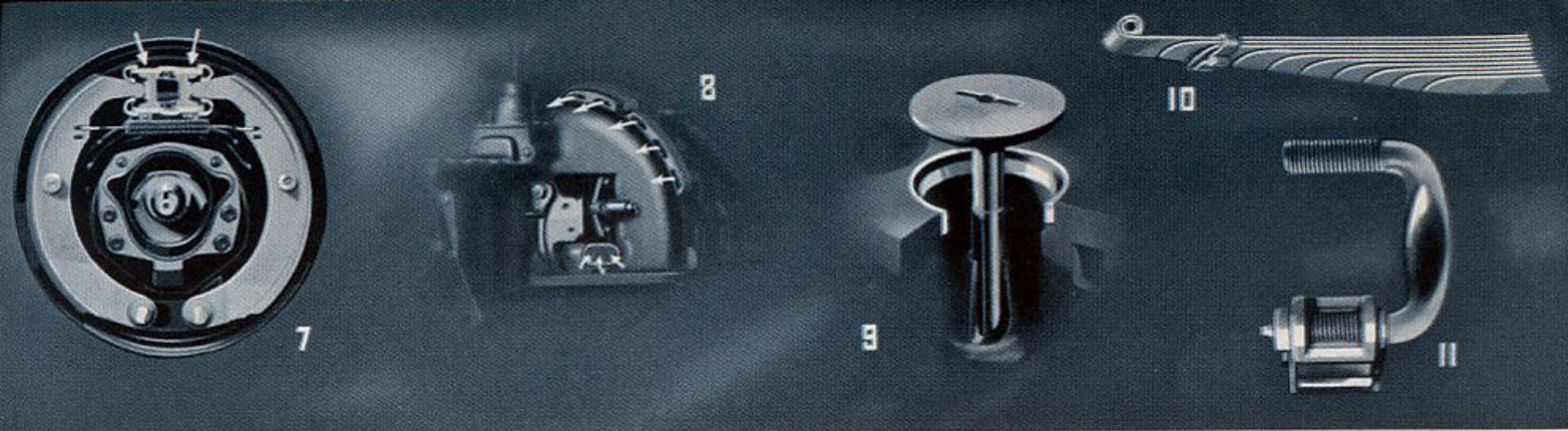

**7** The larger non-corrosive wheel cylinders of Airflow hydraulic brakes are "stepped" to provide equalized effort by both front and rear brake shoes.

**8** Air cooling contributes long life and easy operation to the improved Airflow clutch.

**9** Hardened exhaust valve seat inserts postpone valve grinding and conserve fuel.

**10** Tapered-leaf springs of Amola steel minimize spring noise and incorporate maximum flexibility with great strength.

**11** Silent spring U-shackles allow unusual freedom of movement without side play.

**12** The rigid, tubular front axle is many times stronger than an I-beam front axle of the same weight, contributing to Airflow front end sturdiness.

**13** The steering drag link, like the spring, is anchored at the front. Thus, axle and drag link travel in an identical arc, eliminating road shock in the steering wheel.

**14** The combination of sturdy tubular axle, attuned, flexible Amola steel springs, engine location over the front axle are important contributions to the Airflow Floating Ride.

PRINTED  
IN  
U.S.A.

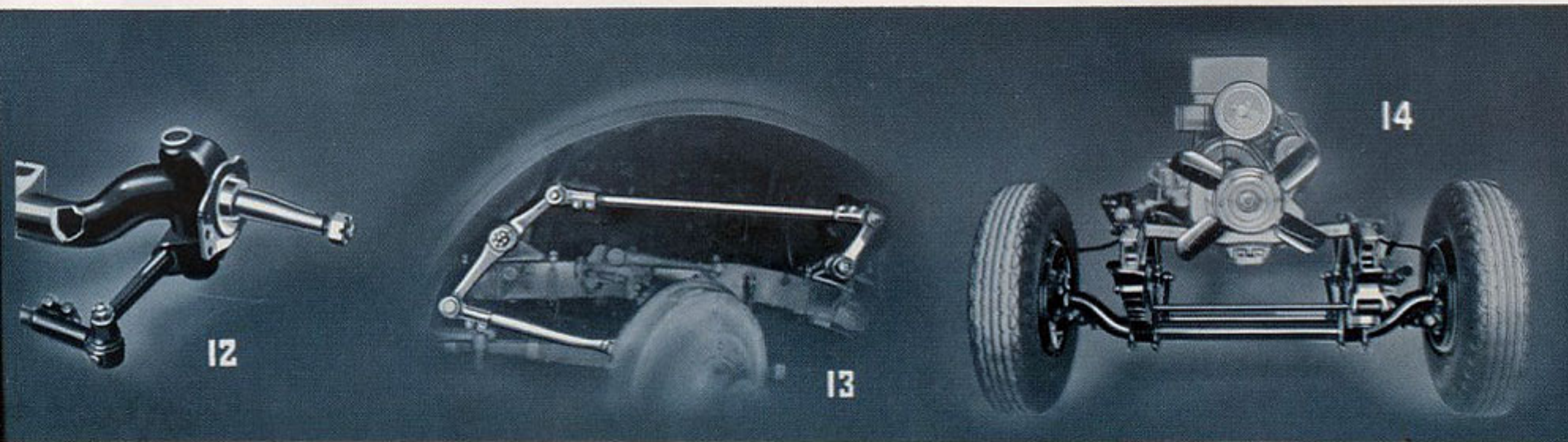



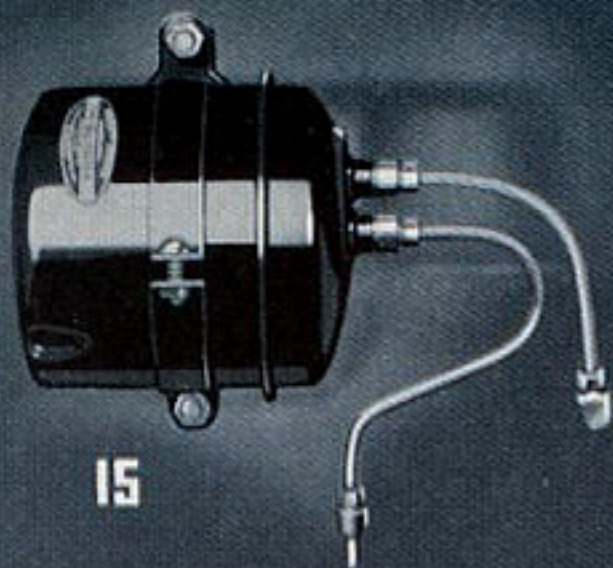

**15** The oil filter cleanses the oil as it flows through the lubricating system, removing all impurities.

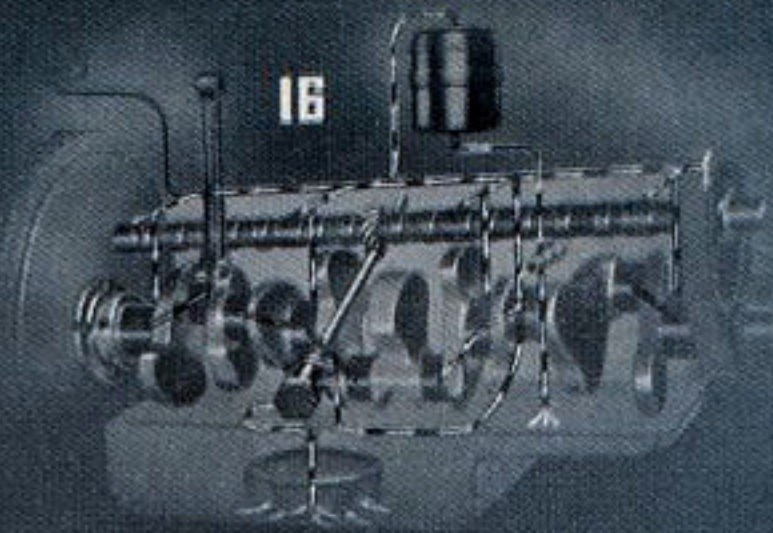

**16** Full-pressure lubrication from the oil pump through rifle-drilled passages in cylinder block and crankshaft to all main, camshaft and connecting rod bearings in the Airflow engine assures long life to the precision-type fittings and bearings.



**17** Immediate satisfactory engine performance in cold weather is assured by the automatic manifold heat control.

**18** Even fuel pressure, regardless of car speed, is maintained by the diaphragm-type fuel pump.

**19** Engine warming is hastened by the by-pass thermostat which routes the water back to the engine until warm enough to pass to the radiator.

**20** Contributing to high compression efficiency, the automatic spark advance with vacuum control instantly adjusts the spark to meet all load conditions.

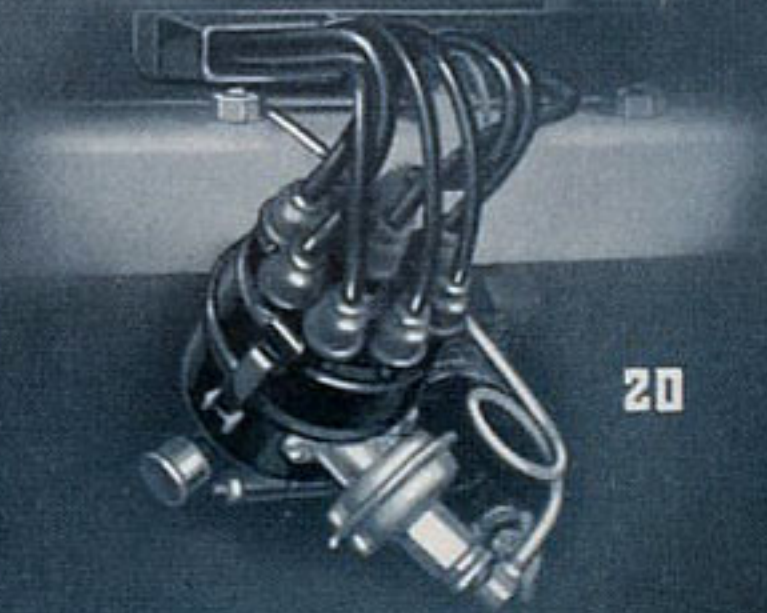
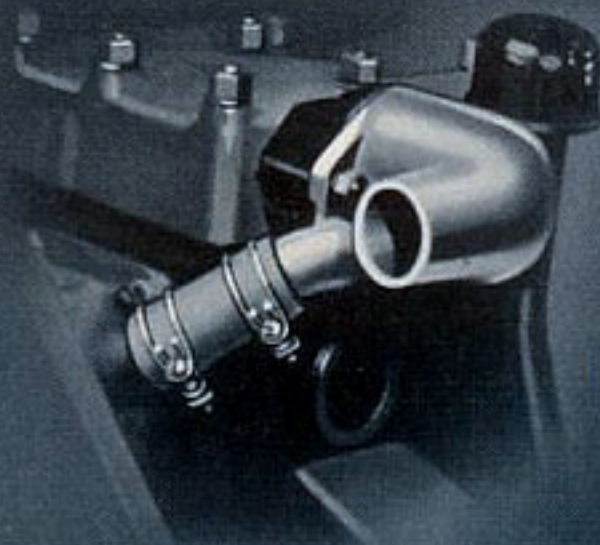
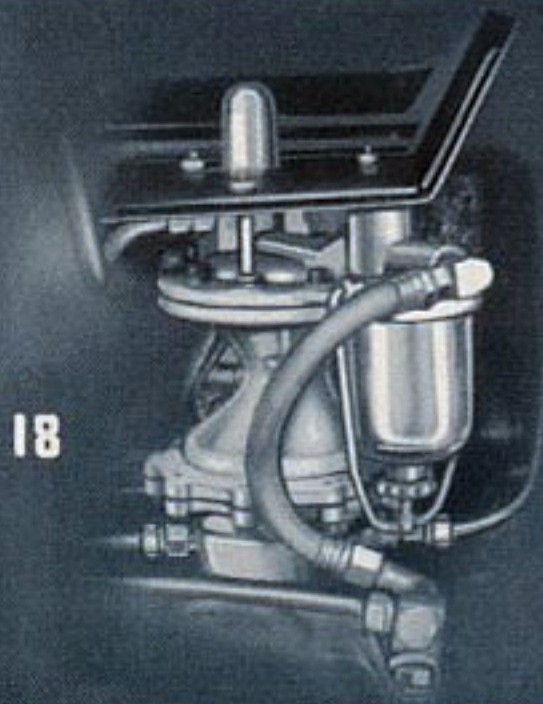



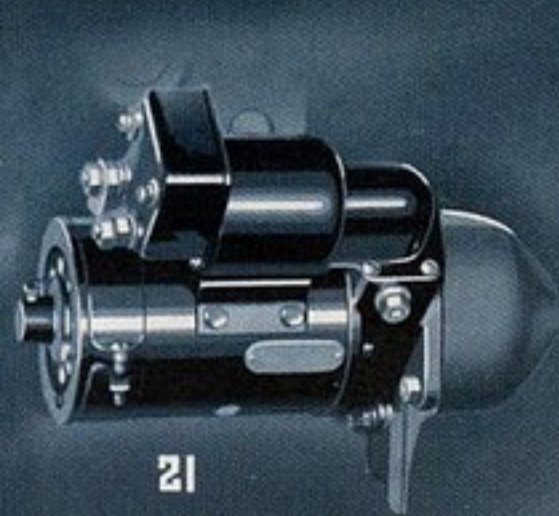

21



22

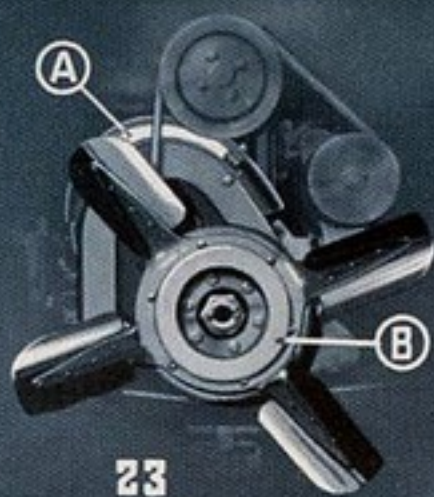

23

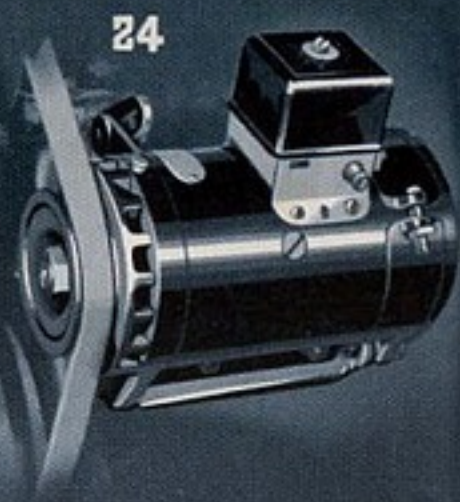

24

**21** Pressing the starter button on the instrument panel activates the solenoid gear shifter which replaces the foot-operated starting lever, and then applies current to the starting motor.

**22** Light-weight aluminum pistons, T-slotted to control expansion and fitted with 4 rings, prevent loss of oil and compression and reduce the strain on the crankshaft. They are anodic-coated for hardness.

**23** (A) Floating Power engine mountings prevent the transfer of engine vibrations to the car. (B) The impulse neutralizer dampens torsional vibration in the engine.

**24** Air cooling permits the generator to produce a greater output of current.

**25** Precision-type main bearings of the heavy-duty type permit replacement without costly fitting operations.

**26** The large, rugged crankshafts are balanced at rest and in motion. Counterweights, cast integrally, balance the weight of the pistons, contributing to long bearing life and smooth performance.

**27** The carburetor aircleaner and silencer keeps abrasive dust out of the cylinders and silences the rush of air into the carburetor.

**28** The large contact area of the chain-driven camshaft assures quiet operation.



25



26



27



28



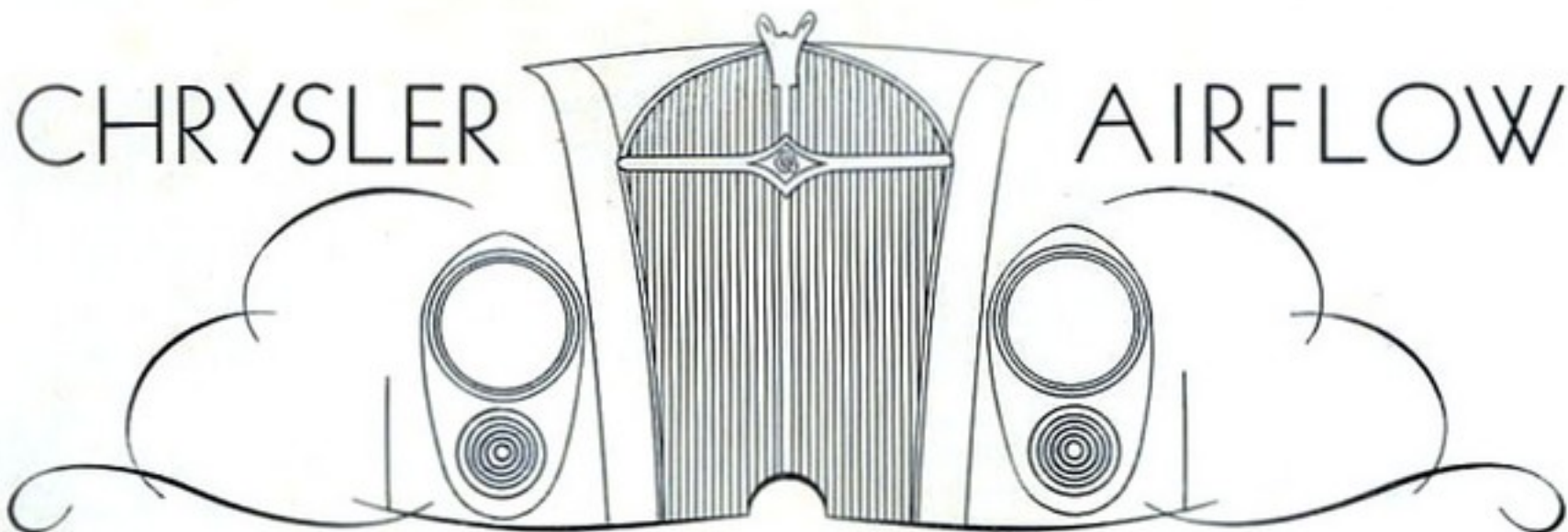

**M**ASTERFUL, imposing styling enhances the distinct individuality of the new Chrysler Airflow models for 1936.

Skilfully refined in the unmistakable fashion of style leaders, these striking new motor cars reflect a predominating new artistic note that subtly blends with their true aerodynamic design.

Five fascinating models in two distinctive groups, all newly magnificent inside and out, afford the best in motoring. Wholly in the functional spirit of scientific Airflow design, these exciting, ultramodern motor cars are even more improved, even more desirable than their epoch-making predecessors.

The Chrysler Airflow Eight, 123-inch wheelbase group is comprised of three models: the Business Coupe, the Six Passenger Coupe and the Four-Door Sedan.

The Chrysler Airflow Imperial, 128-inch wheelbase group includes the Six Passenger Coupe and the Four-Door Sedan.

Besides their sparkling new beauty and new interior and exterior styling, each of these newest models of the car that revolutionized all motoring standards has been engineered for new economy and performance.

No car, however costly, can match the luxurious Floating Ride of the Chrysler Airflow Imperial Coupe or Sedan. For speed, economy, effortless performance, there is literally no equal in the world. These are big, luxurious cars of 128-inch wheelbase that develop 123 horsepower, yet they hold amazing long distance fuel economy records.

The Chrysler Airflow Eight, with its 123-inch wheelbase and developed horsepower of 115, closely approaches the unexcelled performance of the larger Chrysler Airflow Imperial. The same scientific and mechanical engineering principles that provide the famous Floating Ride and the incomparable safety of body and frame have been incorporated in all models.

### **Master Styling Starts at the Front**

The new radiator grille, die-cast for smooth contours and sharpness of detail, is newly attractive in form, size and pattern. It is V-shaped, with a trellis-like arrangement of bright, finely fashioned chromium bars in a solid, convex section that blends into the flowing lines of the hood. The famous Chrysler emblem, the mark of smart, finely engineered motor cars, is worked artistically into the grille pattern. The Chrysler wings top the grille



to form a permanent ornament that symbolizes the swift, smooth flight of the Chrysler Airflow.

### **Artistic Hood Louvers**

Hood louvers of a decidedly new and attractive design contribute, in a large measure, to the refined smartness of the front end appearance. Artistic medallions harmonize splendidly with the advanced, streamlined front end appearance, appropriately suggesting the resistless passage of these cars through the air.

### **Steel Top Enhances Airflow Beauty**

The new and impressive beauty note so apparent at the front of the 1936 Chrysler Airflow models is heightened and blended throughout the entire structure through the new, inset, steel top. Finished to match the body, this new steel top gives the whole upper section of the car a new, sleek lustrousness. A decided advantage of the inset steel top is that it precludes drumming noises by means of its flanged edges which are bolted securely to the roof edges. This top makes an excellent radio aerial and is completely wired and ready for radio connection.

### **Accessible Luggage Compartments**

Commodious luggage compartments, with large entrance doors, are at the rear of all models. Smartly patterned hardware, cam-type, theft-proof locks and non-collapsible supporting brackets distinguish each. Spare tires and wheels are carried within these spacious compartments and on a shelf above and on the floor alongside the spare wheel is space for a surprising amount of luggage.

The removal of the spare wheel to the interior permits unobstructed access to these compartments which, on the Four-Door Sedans, take the form of a built-in trunk that conforms with the sweeping contour of roof and rear end. It is so shaped that it cannot set up air eddies or other interruptions of the air stream that might tend to retard the easy forward movement of the car.

### **Smart Interiors Greatly Refined**

Amazing improvements that add even more to Chrysler Airflow comfort and roominess, together with notable refinements that provide new standards of luxury, smartness and modern style, have been incorporated in all models. Adding complete comfort and relaxation to the thrill of driving the Chrysler Airflow are the ingenious new front seats that may be adjusted upward, downward, backward and forward to the precise position that provides maximum comfort.

### **New Instrument Panel**

Originality in style and finish distinguishes the new instrument panel which combines a large speedometer and tachometer at one side of the centered group of instruments. As the needle of the speedometer revolves, it points to three sets of figures: one showing the road speed, another showing the engine revolutions in conventional high gear and another showing the engine revolutions in the amazingly economical and sensationally smooth automatic overdrive which is standard equipment on the Airflow Imperial; special equipment on the Airflow Eight.

### **Airflow Roominess**

The wide, aerodynamic front of the Chrysler Airflow permits the use of front seats of exceptional width. A feeling of restful freedom results even with a car full of passengers. Most of the Airflow interior dimensions are more generous than on any type of car of comparable wheelbase.

In the rear compartment of sedan models, a new foot rest, recessed into the back of the front seat, provides several inches more leg-room. Arm rests in both compartments have been redesigned, providing a most comfortable position for the elbow. Ash receivers, with snap lids, are now located in the front of the rear seat arm rests. The new drop-type robe rail, in sedans, is more convenient and adds another distinctive touch to the interior appearance.



A new center arm rest of broad proportions is built into the rear seat back, for use in steadying the rear seat passengers when only two occupy the seat. When three are to be carried, the new arm rest folds into the back where it functions as part of the wholly comfortable, newly upholstered seat.

### **Complete Body Ventilation**

Simplicity distinguishes the Airflow ventilating system. In all models, the front door window has an easily adjustable ventilating wing. Front and rear door windows may be completely lowered, and the rear quarter windows pivot outward. Two screened cowl ventilators and two ventilating windshields operated by conveniently located, easy-operating cranks permit any volume of air to enter at the driver's will.

### **Correct Weight Distribution**

Only in Airflow models can weight be distributed so perfectly. In these cars, the passengers are cradled in the center of the car. Engine and seats are located at a point considerably forward of those in a conventional car, resulting in a ride of the least jarring and the least upward and downward motion. This exclusive feature, plus the lengthened springs of ultraflexible Amola steel which are attuned in action to normal human movement, provide the easy, restful Airflow Floating Ride.

### **LifeGuard Tire Tubes**

All the 1936 Airflow models are equipped with LifeGuard tire tubes as a final link in the chain of safety features that distinguish the Airflow.

This tube is a heavy-duty tube with a second tube built inside. These twin tubes, one inside the other, are inflated from a single valve. Should the tire become weakened or damaged sufficiently to cause a blowout, only the outer tube blows out. The inner tube remains inflated for a length of time sufficient to bring the car to a stop before damage to the tire, the car or the passengers might result.

### **Automatic Overdrive**

Imparting a sensational thrill, even to the Airflow Floating Ride and, with it, further economies in fuel, in oil and in engine wear, the Chrysler automatic overdrive is termed a modern miracle of motoring.

This remarkable transmission is supplied as standard equipment on the Chrysler Airflow Imperial, and as special equipment at additional cost on the Chrysler Airflow Eight. At the option of the driver, the overdrive comes into action automatically at an approximate car speed of about forty miles an hour, instantly reducing the engine speed and effort by one-third. It creates an utterly thrilling sensation of being impelled, at high speeds, by an unseen hand, yet the driver has full control, as in a conventional transmission. Engine roar at the higher speeds is reduced to a mere hum. Fuel, oil and engine wear reduce, at once, in ratio to the one-third reduction in engine revolutions, resulting in amazing economies in operation and maintenance.

### **Perfected Hydraulic Brakes**

Chrysler Airflow hydraulic brakes are perfected. Behind them are years of development and manufacturing experience. Every Chrysler-built car has employed them. Years of experience and millions of miles of service have attested their safety, reliability, ease of action and minimized upkeep. Airflow brakes provide equal braking pressure on all four wheels. With their non-oxidizing, "stepped" wheel cylinders, each brake shoe exerts equal braking force and pedal pressure remains constant so the Airflow driver is always aware of the foot pressure needed for each stop, whether for ordinary slackening of speed or for emergency stops.

Centrifuse brake drums, combining the light weight of steel and the ideal braking characteristics of cast iron are used on all Airflow models. They have a steel shell lined with cast iron of ideal grain and texture to rapidly dissipate heat and reduce the possibility of scoring and distortion with consequent lowered cost of brake maintenance.

Throughout the Airflow line, Chrysler engineering has attained its highest form of experience.



# S P E C I F I C A T I O N S

## AIRFLOW CHRYSLER EIGHT

### 123-inch wheelbase

**AXLE (Front)**—Reverse Elliott seamless tubular—Ball thrust bearing at base of steering knuckle head—Road clearance 8½".

**AXLE (Rear)**—Semi-floating pressed steel housing—Drive gears chrome nickel steel, spiral bevel type—Axle shaft chrome molybdenum steel—Road clearance 9½".

**BODY (All-Steel)**—Body frame and sill are welded into one unit—trussed and braced with steel at all points of stress.

**BRAKE (Parking)**—External contracting on cast-iron drum located on drive shaft at rear of transmission.

**BRAKES (Service)**—Chrysler internal-expanding hydraulic, all four wheels—Centrifuge brake drums, cast-iron lined, drum diameter 13"–2" wide—Total contact area per car 198.8 sq. in.

**CARBURETOR**—Down-draft, Aircleaner integral with intake silencer—Automatic choke and manifold heat control.

**CLUTCH**—Single dry-plate type—fully ventilated. Torque cushioned by special coil springs.

**COOLING SYSTEM**—Water circulated by centrifugal pump—Cylinders and valves completely surrounded by large water passages—Water flow controlled by by-pass thermostat—Water capacity 4½ gallons (17.07 liters)—Silent four-blade fan with impulse neutralizer mounted at end of crankshaft—Fan blades 20".

**CRANKSHAFT**—Statically and dynamically balanced—Eight counterweights forged integral with crankshaft—Supported on 5 steel-backed bearings—Bearing diameter 2½"—Total bearing area 62.1 sq. in.

**ENGINE**—L-head type, water-cooled, eight cylinders—Bore 3¼" (82.5 mm.), Stroke 4½" (123.9 mm.)—S. A. E. horsepower 33.80—Developed horsepower at 3400 r.p.m. 115—Piston displacement, 323.5 cu. in. (5301.19 cc.)—Engine mounting Floating Power—Firing order 1-6-2-5-8-3-7-4—Camshaft drop-forged with cams and distributor drive gear integral, six bearings—Exhaust valve seat inserts of tungsten high-speed tool steel—Full-pressure lubrication to all crankshaft, camshaft and connecting rod bearings, also throw from crankshaft and camshaft—Timing chain lubricated by direct oil leads—Oil pump driven by timing shaft from spiral gear on camshaft—Oil filter—Oil capacity 6 quarts (5.77 liters)—Pressure gauge on dash—Level indicator on left side of crankcase—Crankcase ventilator.

**ELECTRICAL SYSTEM**—"Balanced Armature" Generator, third brush and voltage limit control—full positive ventilation—six-volt, Battery, six-volt, 136-ampere hour capacity—Waterproof distributor, single breaker arm type, full automatic advance, speed and vacuum control.

**FUEL SYSTEM**—Down-draft carburetor, plain tube type, with idle speed adjustment and fixed jets—adjustable accelerating pump, automatic choke and idle control—Positive fuel pump, intake silencer, aircleaner and automatic manifold heat control—Fuel feed pump driven from camshaft—Fuel tank 21 gallons (79.48 liters).

**PISTONS**—Special anodic treated aluminum type—T-slot type—two compression and two oil rings per piston.

**PISTON PIN**—Floating type—chrome nickel steel-bearing in piston and rod.

**PROPELLER SHAFT**—Tubular, roller bearing type universal joints.

**SPRINGS**—Semi-elliptic new tapered-leaf—front, length 44", width 2", fourteen leaves—rear, length, 56½", width 2"—silent U-shackles, threaded—Rubber bushings on front end of rear springs.

**STEERING GEAR**—Mounted forward of left front axle—Worm and roller type, ratio 20.25 to 1, adjustable for wear—adjustable steering column—Road shock eliminator at front end of left front spring.

**TIRES**—Airwheel, 4-ply, non-skid tread all wheels—size 7.00 x 16". LifeGuard tubes standard equipment.

**TRANSMISSION**—Synchro-Silent, helical type gears throughout, first speed and reverse operating on spirally cut spline—second speed operates on constant mesh helically cut gear. Overdrive available as extra equipment.

**WHEELBASE**—123" (3.12 meters)—Over-all length bumper to bumper 206½" (5.24 meters)—Tread 37".

**STANDARD EQUIPMENT**—All body styles—double-acting adjustable hydraulic shock absorbers—adjustable front seat—Two automatic windshield wipers—non-glare rear view mirror—Two combination stop and tail lights—Dual trumpet horns mounted under hood—Dome light operated by switches—Two inside adjustable sun visors—Duplate Safety Glass in all windshields—Wheel equipment, five steel spoke with spare mounted at rear. Information and specifications subject to change without notice and without responsibility to the Chrysler Corporation, Export Division.

## AIRFLOW CHRYSLER IMPERIAL

### 128-inch wheelbase

**AXLE (Front)**—Reverse Elliott seamless tubular—Ball thrust bearing at base of steering knuckle head—Road clearance 9½".

**AXLE (Rear)**—Semi-floating pressed steel housing—Drive gears chrome nickel vanadium steel, spiral bevel type—Axle shaft chrome molybdenum steel. Road clearance 9½".

**BODY (All-steel)**—Body frame and sill are welded into one unit—trussed and braced with steel at all points of stress.

**BRAKE (Parking)**—External contracting on cast-iron drum located on drive shaft at rear of transmission.

**BRAKES (Service)**—Chrysler internal-expanding hydraulic, equipped with vacuum power booster, all four wheels—Centrifuge brake drums cast-iron lined—drum diameter 13"–2" wide—Total contact area for car 198.8 sq. in.

**CARBURETOR**—Dual down-draft—Aircleaner integral with intake silencer—Automatic choke and manifold heat control.

**CLUTCH**—Single dry-plate—fully ventilated. Torque cushioned by special coil springs.

**COOLING SYSTEM**—Water circulated by centrifugal pump. Cylinders and valves completely surrounded by large water passages—Water flow controlled by by-pass thermostat—Water capacity 4½ gallons (18.45 liters). Silent four-blade fan with impulse neutralizer mounted at end of crankshaft—Fan blades 20".

**CRANKSHAFT**—Statically and dynamically balanced—Eight counterweights forged integral with crankshaft—Supported on 5 steel-backed bearings—Bearing diameter 2½"—Total bearing area 62.1 sq. in.

**ENGINE**—L-head type, water-cooled, eight cylinders—Bore, 3¼" (82.5 mm.), Stroke 4½" (123.9 mm.)—S. A. E. horsepower 35.80—Developed horsepower at 3400 r.p.m. 123. Piston displacement, 323.5 cu. in. (5301.19 cc.)—Aluminum cylinder head—Engine mounting Floating Power—Firing order 1-6-2-5-8-3-7-4. Camshaft drop-forged with cams and distributor drive integral—six bearings—Exhaust valve seat inserts tungsten high-speed tool steel—Full-pressure lubrication to all crankshaft, camshaft and connecting rod bearings, also throw from crankshaft and camshaft—Timing chain lubricated by direct oil leads—Oil pump driven by timing shaft from spiral gear on camshaft—Oil filter—Oil capacity 6 quarts (5.77 liters)—Pressure gauge on dash—Level indicator on left side of crankcase—Crankcase ventilator.

**ELECTRICAL SYSTEM**—"Balanced Armature" Generator, third brush and voltage limit control, six-volt type—Battery, six-volt, 136-ampere hour capacity—Waterproof distributor, single breaker arm type, full automatic advance.

**FREE WHEELING**—Two bearing, selective cam and roller type located at rear of transmission—Lockout button on instrument panel—Operates in all forward speeds, automatic lockout in reverse.

**FUEL SYSTEM**—Dual down-draft carburetor with idle speed adjustment and fixed jets—Positive fuel pump driven from camshaft, adjustable accelerating pump, automatic choke and idle control, intake silencer, aircleaner, automatic manifold heat control—Fuel tank 21 gallons (79.48 liters).

**OVERDRIVE**—All helical planetary gears—silent operation—provides slower engine speed at higher car speeds resulting in longer life, greater economy and smoother performance operation—automatic through accelerator pedal.

**PISTONS**—Special anodic treated aluminum alloy—T-slot type—two compression and two oil rings per piston.

**PISTON PIN**—Floating type—chrome nickel steel-bearing in piston and rod.

**PROPELLER SHAFT**—Tubular, roller bearing type universal joints.

**SPRINGS**—New tapered-leaf type—Semi-elliptic, front, length 44", width 2½"—rear, length 56½", width 2", twelve leaves, silent U-threaded shackles—Rubber bushing on front end of rear springs.

**STEERING GEAR**—Mounted forward of left front axle—Worm and roller type, ratio 20.5 to 1, adjustable for wear—Adjustable steering column—Road shock eliminator at front end of left front spring.

**TIRES**—Airwheel—4-ply—non-skid tread on all wheels—size 7.50 x 16". LifeGuard tubes standard equipment.

**TRANSMISSION**—Synchro-Silent transmission, helical type gears throughout, first speed and reverse operating on spirally cut spline, second speed operates on constant mesh helically cut gear—Overdrive unit at rear.

**WHEELBASE**—128" (3.25 meters). Over-all length with bumpers 215½" (5.36 meters)—Tread 37"

**STANDARD EQUIPMENT**—All body types, double-acting adjustable hydraulic shock absorbers—adjustable front seat—Two automatic windshield wipers—non-glare rear view mirror—Two combination stop and tail lights—Dual trumpet horns mounted under hood—Two dome lights operated by door switches—Two inside adjustable sun visors on all models. Duplate Safety Glass in all windshields and pivoting ventilating wings. Wheel equipment—five steel spoke wheels with spare mounted in the rear. Information and specifications subject to change without notice and without responsibility to the Chrysler Corporation, Export Division.