



Innovation  
that excites

## 2015 TITAN®

### WELCOME TO THE 2015 NISSAN TITAN® DIGITAL BROCHURE

Full of images, feature stories, and all the specification and trim level information you need to help select your Titan.®

[Click here](#) to sign up for news and updates on the 2015 Nissan Titan.®



**WHAT IF\_**  
**EPIC CAME AS**  
**STANDARD EQUIPMENT?**

Ready to expand your horizons? It's easy in the Nissan Titan.<sup>®</sup> It starts with a powerful standard V8 engine that hits the road with up to 9,500 lbs. of towing capacity.<sup>1</sup> Underneath, a fully boxed ladder frame handles just about any job on the list, while Titan's cabin and bed give you Nissan innovation plus plenty of room. 2015 Nissan Titan.<sup>®</sup> No matter how epic your plans, it's ready.



Nissan Titan<sup>®</sup> SL Crew Cab 4x4 shown in Brilliant Silver with optional equipment and accessory Telescoping Tow Mirrors, 20" Chrome Wheels and Chrome Billet Grille.

<sup>1</sup>See Nissan Towing Guide and Owner's Manual for proper use.



Nissan Titan® SV Crew Cab 4x4 shown in Magnetic Black with Value Truck Package and accessory Splash Guards.



Nissan Titan<sup>®</sup> PRO-4X<sup>®</sup> King Cab<sup>®</sup> 4x4 shown in Cayenne Red.



Nissan Titan® PRO-4X® King Cab® 4x4 shown in Glacier White with optional equipment.

Cargo and load capacity limited by weight and distribution. Always secure all cargo. Heavy loading of the vehicle with cargo, especially on the roof, will affect the handling and stability of the vehicle.

## OPEN POSSIBILITIES.

Capability is king, and with the 168° Wide Open rear doors on Titan® King Cab®, entering or loading the cabin is a snap. And with no B-pillar to get in the way, plus a fold-up rear bench seat, your cargo flexibility is as wide open as your doors.

### TITAN® KING CAB® FEATURES



6' 7"

Over 6.5 feet  
of bed length

Two available seating configurations:  
6-passenger with front bench seat or  
5-passenger with front captain's chairs

Standard rear fold-up bench  
seat and a flat loading floor  
give you more usable area

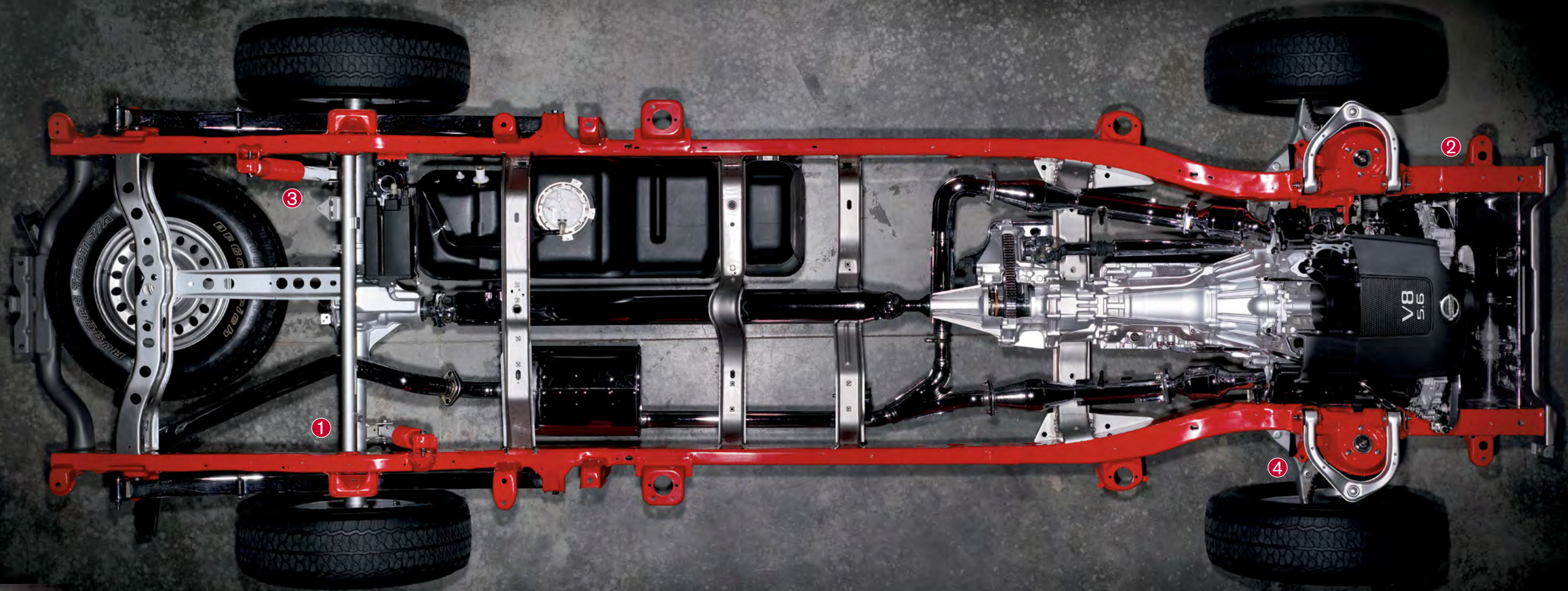

## FOUR WALLS ARE STRONGER THAN THREE.

To build a better truck, sometimes you need to think inside the box. As in the fully boxed full-length ladder frame that's at the core of every Titan.® Some of our competitors use 3-sided open "C" rails instead. But you don't need to be a structural engineer to know the obvious – when building, four walls are stronger than three.

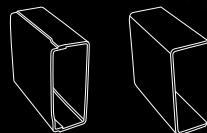

At its core, every Titan® stocks a fully boxed ladder frame, plus components built for no-nonsense performance.

- ① **Dana® axles** are built for durability. Wherever there's a drive wheel, there's a Dana® axle.
- ② **Heavy-duty suspension** gives a smooth ride and firm, responsive handling. Double-wishbone up front, and multi-leaf springs in the rear.
- ③ **Rancho® shocks** set the standard for off-road toughness. Just what you'd expect from Titan.®
- ④ **Beefy brakes** provide maximum contact area for rapid heat dissipation, long-lasting durability and confident towing.

317<sup>HP</sup>

385<sup>LB-FT</sup>  
OF TORQUE

9,500<sup>LBS. MAXIMUM</sup>  
TOWING<sup>1</sup>



## THE FEELING OF REELING IN THE BIG ONE.

It's always a good haul with a massive 5.6-liter V8. Punch the pedal and the exhaust system growls, while 385 lb-ft of torque kicks in to get the job done. This is one place where you don't want to hear about the one that got away.

### What's power without torque?

Especially the brute force of low-rev torque, i.e., 80% under 1,000 rpm and 90% under 2,500 rpm. Feel confident – Titan's got it.

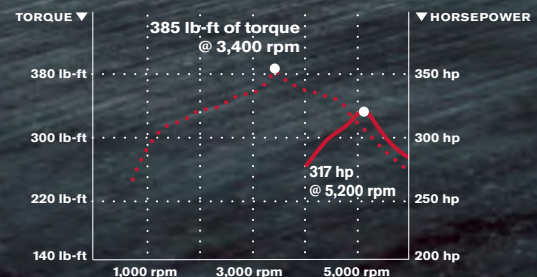

**Give yourself an efficiency boost.** The Nissan Titan® features a high-flow intake that maximizes every heaping gulp of air. Molybdenum-coated pistons and microfinished valves cut friction, ramp up smoothness and let revs rise faster.

**Harness the power of E85.** The Titan® Flexible Fuel Vehicle (FFV) engine works with ethanol E85, standard unleaded or any mixture of the two fuels.<sup>2</sup>

**Tow to the max.** For that full 9,500-lb. maximum pull, the SV Premium Utility Package<sup>1</sup> boasts a lower final gear ratio, plus features like extendable tow mirrors and a heavy-duty battery. For the full list of package equipment, please see the Specifications section of this brochure.

<sup>1</sup>9,500 lbs. maximum towing on Titan SV King Cab 4x2 with Premium Utility Package. Towing performance and speed are affected by vehicle payload, tow weight, road grades and weather conditions, including high temperatures. See Nissan Towing Guide and Owner's Manual for proper use. <sup>2</sup>Flexible Fuel Vehicle is not available in all states.

Nissan Titan® SV King Cab® 4x2 shown in Brilliant Silver with optional equipment.



## PLAYGROUND OF THE EXTREMELY CAPABLE.

Climb, crawl, and throw some dirt. You're in the right truck to do it. With shift-on-the-fly 4WD<sup>1</sup> and traction-boosting off-road gear, Titan<sup>®</sup> grips the terrain to help keep you moving right on through. And when you take a break, you can admire the dark-finished wheels and satin chrome-finished front grille.

**E-locker.** Exclusive to Titan<sup>®</sup> PRO-4X<sup>®</sup>, when 4-Wheel Drive LO isn't enough for the crawl you've got planned, the available electronic locking rear differential is ready and extremely able. Flip the switch and this ultimate off-road feature delivers equal power to both rear wheels to help boost traction and help keep your truck moving forward.

**4-Wheel Limited Slip.** Helps keep your wheels from spinning. All Titan<sup>®</sup> models include ABLs, a system that senses when a wheel begins to slip, then automatically brakes the slipping wheel (or wheels) and sends additional power to the wheels with the best traction.

**Off-road-tuned Suspension.** Take the bumps like a professional. Titan<sup>®</sup> PRO-4X<sup>®</sup>'s off-road-tuned suspension includes legendary Rancho<sup>®</sup> shocks. Teamed with unique dark-finished wheels and BFGoodrich<sup>®</sup> Rugged Trail<sup>®</sup> tires, you've got real composure to help get you through the ugly stuff.

**PRO-4X**

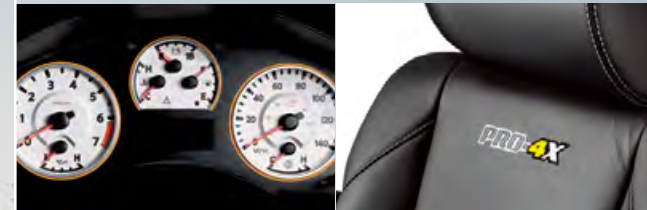

**For those who like to live off-off-off the beaten path,** the only choice is Titan<sup>®</sup> PRO-4X<sup>®</sup>. With extras like electronic locking rear differential, Rancho<sup>®</sup> off-road shocks, additional underbody skid plates – not to mention unique white-faced gauges and all-new leather PRO-4X<sup>®</sup> branded seats – it's got the gear, the guts, the technology to handle it in places where success is measured in feet per minute.

<sup>1</sup>At speeds up to 60 mph. Always drive safely. BFGoodrich<sup>®</sup> is a registered trademark of Goodrich Corporation. Rancho<sup>®</sup> is a registered trademark of Tenneco Automotive Operating Company, Inc. Rugged Trail<sup>®</sup> is a registered trademark of Uniroyal Goodrich Licensing Services, Inc.

## NISSAN UTILI-TRACK® CHANNEL SYSTEM

### INNOVATION THAT PUTS THE SUBMISSION HOLD ON CARGO.

Nissan's first-in-class Utili-track® cargo-carrying system holds a huge advantage over other trucks.<sup>1</sup> With five channels, including two on the bed floor, not just in the walls and header, you can have your way with cargo. Just position the four beefy, aluminum-alloy cleats anywhere along the tracks, strap in your cargo, and put even the most awkward loads on lockdown.<sup>2</sup>

Nissan's revolutionary Utili-track® system may have been copied by others, but its level of flexibility leads the way among full-size trucks. Add in an available spray-on bedliner, and Titan® gives you one smart, long-lasting bed to haul what you need, work or play.<sup>2</sup>

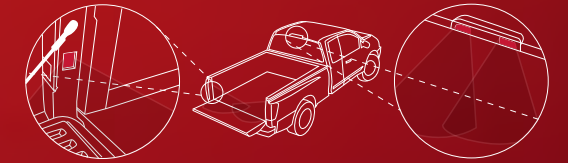
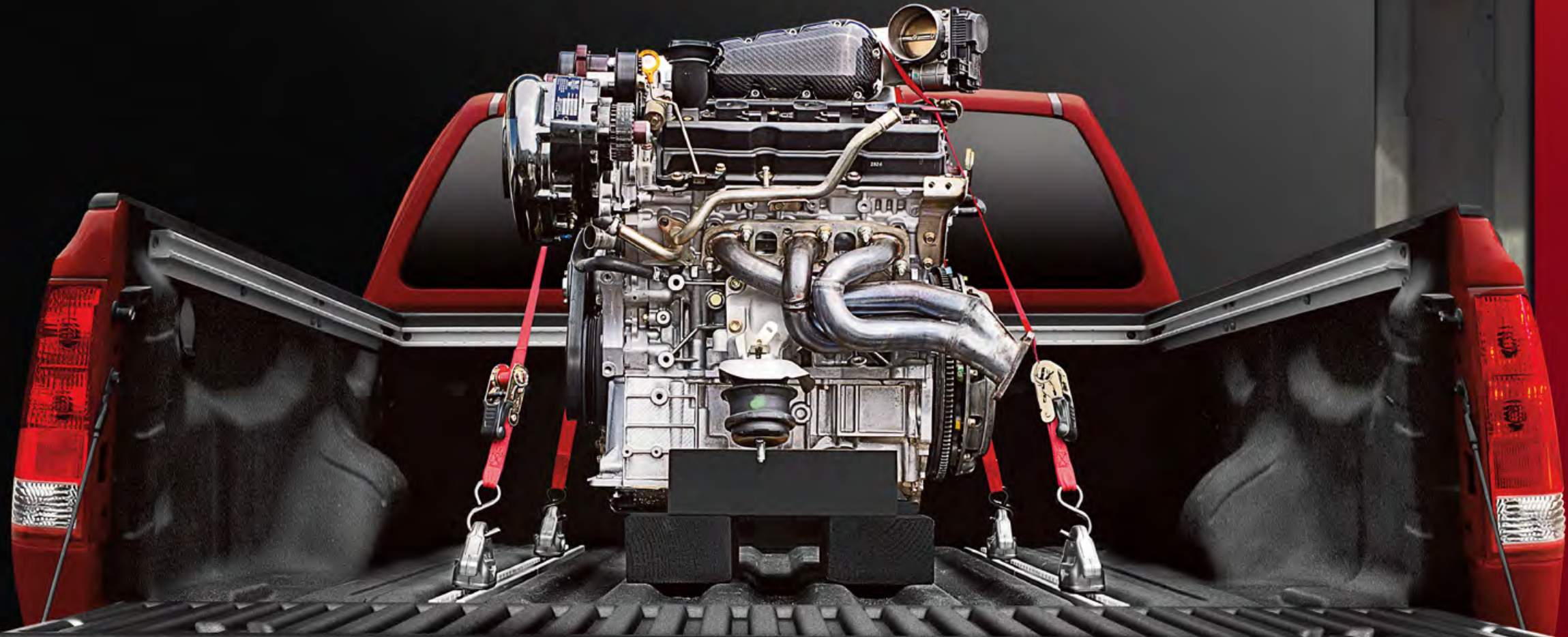

**Bed Light and Tailgate Light** Shine a light on innovation. A pair of lights beam down into the bed; two other available task lights near the tailgate help you keep an eye on the job at hand.

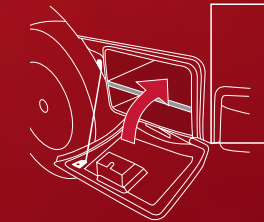

**Bedside Storage** Another smart feature you'll only find on Titan®: an available driver-side tool box. It's climate-resistant, dual-level and lockable.



**First-in-class Spray-on Bedliner**<sup>1</sup> The available spray-on bedliner helps resist the wear and tear of constant use, plus its UV-resistant surface helps guard against fading and the weather. And because it's sprayed on directly at the factory, it also fights warping and rust.

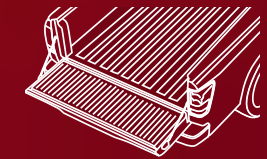

**Tailgate Assist** Easy does it. Thanks to an available strut, the tailgate on a Titan® feels lighter and can be opened and closed with only one hand.



**120-volt AC Power Outlet** Power where you need it. Titan®'s available 120-V outlet in the driver-side rear corner of the bed is perfect for powering or charging the tools you bring along.

<sup>1</sup>Ward's Segmentation, 2015 Titan® vs. 2013 Large Pickup Class.  
<sup>2</sup>Cargo shown for display purposes only. Cargo and load capacity limited by weight and distribution. Always secure all cargo. Heavy loading of the vehicle with cargo, especially on the roof, will affect the handling and stability of the vehicle.



**EVEN REFINEMENT COMES IN KING-SIZE PORTIONS.**

Nissan® Titan® SL Crew Cab shown in Charcoal Leather.

**RearView Monitor.** Titan's available RearView Monitor not only helps you see what's directly behind you, but comes in real handy when you're hitching a trailer.<sup>1</sup>

 **Rockford Fosgate**

<sup>1</sup>Parking aid/convenience feature. Cannot completely eliminate blind spots. May not detect every object and does not warn of moving objects. Always check surroundings and turn to look behind you before moving vehicle. <sup>2</sup>Availability of specific features is dependent upon the phone's Bluetooth® support. Please refer to your phone Owner's Manual for details. Bluetooth® word mark and logos are owned by Bluetooth SIG, Inc., and any use of such marks by Nissan is under license. <sup>3</sup>Required SiriusXM® Satellite Radio, SiriusXM® Traffic and SiriusXM® Travel Link® services subscriptions sold separately and are continuous until you call SiriusXM to cancel. Installation costs, one-time activation fee, other fees and taxes will apply. SiriusXM Travel Link services available in select markets. Satellite Radio U.S. service, SiriusXM® Traffic and SiriusXM® Travel Link Services® available only to those 18 or older in the 48 contiguous states and D.C. Fees and programming subject to change. Subscriptions governed by Customer Agreement available at [siriusxm.com](http://siriusxm.com). ©2014 Sirius XM Radio Inc. Sirius® XM® and all related marks and logos are trademarks of Sirius XM Radio Inc. iPod® is a registered trademark of Apple, Inc. All rights reserved. iPod® not included. Rockford Fosgate® is a registered trademark of Rockford Corporation.

## TECHNOLOGY THAT'LL HOOK YOU UP.

Whether you're on the job or heading for the high country, Titan's available innovative technology makes it easy to keep you connected to your world.



**Nissan Mobile Entertainment System.** Makes entertaining the whole crew easy with an available flip-down monitor.



**Bluetooth® Hands-free Phone System.** Lets you make and take calls with your hands on the wheel.<sup>2</sup>



**120-volt AC power outlet.** A 120-volt outlet on the back of the console lets you charge your laptop while it's safely concealed inside.



**Rockford Fosgate®-powered audio.** Your tunes have never sounded better than through this available 10-speaker system. With available SiriusXM® Satellite Radio,<sup>3</sup> you're spoiled for choice, too.

NissanConnect<sup>SM, 2</sup>

# YOUR WORLD, AT YOUR FINGERTIPS.

With NissanConnect<sup>SM</sup> with Mobile Apps,<sup>1, 2</sup> your Titan<sup>®</sup> becomes your smartphone's best friend. Which means no more separation anxiety for you. Because now, your own hand-picked music, Facebook<sup>®</sup> news feed, latest tweets, TripAdvisor<sup>®</sup> tips, and more all come along for the ride, working seamlessly together through your smartphone and Titan<sup>®</sup>'s 5-inch color touch-screen. And it keeps on getting better: the basic app package is complimentary for the first three years.<sup>1, 2</sup>



Your Nissan<sup>®</sup> Titan<sup>®</sup> also keeps you in the loop with the Nissan Navigation System (featuring voice recognition),<sup>1, 3</sup> hands-free text messaging assistant,<sup>1, 4</sup> Bluetooth<sup>®</sup> hands-free calling<sup>5</sup> and streaming audio,<sup>1, 5</sup> plus an iPod<sup>®</sup>/USB input.<sup>1, 6</sup>

CLICK  
HERE

Click here for the full story on NissanConnect<sup>SM</sup> with Mobile Apps.<sup>1, 2</sup> Or go to [bit.ly/titanconnect15](http://bit.ly/titanconnect15)

<sup>1</sup>Available feature. <sup>2</sup>Driving is serious business. Only use NissanConnect<sup>SM</sup> services when safe to do so. Subscription Agreement required. Compatible smartphone required. Not all app features are available for all models. Some apps have late availability. May require dealer service visit or software upgrade to activate. Never program while driving. GPS mapping may not be detailed in all areas or reflect current road status. Cellular network not available in all areas. Cellular network, apps, and services, including Google<sup>®</sup> services, are provided by independent companies not within Nissan's control and may require subscription and owner consent to activate. Should provider terminate/restrict service, service may be terminated without notice or liability to Nissan and/or its agents. Nissan not responsible for any equipment or app replacement/upgrades, or associated costs, that may be required for continued operation. Terms and conditions of Subscription Agreement apply. 36-month trial period starts on vehicle sale date; subsequently a paid subscription is required at the then current rate (excludes Pandora<sup>®</sup>). Standard text rates and/or data usage may apply. See retailer and check [www.NissanUSA.com/connect](http://www.NissanUSA.com/connect) for details. <sup>3</sup>Never program while driving. GPS mapping may not be detailed in all areas or reflect current road status. <sup>4</sup>Use the text messaging feature after stopping your vehicle in a safe location. If you have to use the feature while driving, exercise extreme caution at all times so full attention may be given to vehicle operation. Compatible smartphone required. Standard text rates and/or data usage may apply. <sup>5</sup>Availability of specific features is dependent upon the phone's Bluetooth<sup>®</sup> support. Please refer to your phone Owner's Manual for details. Bluetooth<sup>®</sup> word mark and logos are owned by Bluetooth SIG, Inc., and any use of such marks by Nissan is under license. <sup>6</sup>Driving is serious business and requires your full attention. If you have to use the connected device while driving, exercise extreme caution at all times so full attention may be given to vehicle operation. iPod<sup>®</sup> is a registered trademark of Apple, Inc. All rights reserved. iPod<sup>®</sup> not included. The App Store<sup>®</sup> logo is a registered trademark of Apple, Inc. All rights reserved. Facebook<sup>®</sup> is a registered trademark of Facebook, Inc. Google<sup>®</sup> and the Google Play logo are registered trademarks of Google Inc. iHeartRadio<sup>™</sup> is a trademark of Clear Channel Broadcasting Inc. Pandora<sup>®</sup> is a registered trademark of Pandora Media. The Sirius<sup>®</sup> XM<sup>®</sup> and SiriusXM<sup>®</sup> names and all related marks and logos are trademarks of Sirius XM Radio Inc. TripAdvisor<sup>®</sup> is a registered trademark of TripAdvisor LLC.



**Titan® takes your comfort personally – even if you have to share sometimes.**

Premium details include an available memory function that locks in the perfect settings for your driver's seat, outside mirrors and power adjustable pedals. Dual Zone Automatic Temperature Control (ATC) that lets you and your front passenger set your own climates. And when the temperature dips outside, available heated front seats warm things up.

Nissan Titan® PRO-4X® Crew Cab 4x4 shown in Charcoal Leather with optional equipment.

# NISSAN SAFETY SHIELD® PHILOSOPHY INNOVATION THAT LOOKS OUT FOR YOU.

Wouldn't it be cool if you had the confidence you need for every part of your drive? The Nissan Safety Shield® is a comprehensive approach to safety that guides the engineering and development of every vehicle we make.

## MONITOR

Smart technologies are designed to help monitor conditions. Like a rearview camera that helps you see something directly behind you, or a system that helps ensure you're travelling on properly inflated tires.

### Tire Pressure Monitoring System<sup>1</sup>

Lets you know when a tire is low, so you don't have to guess.

### Available Automatic On/off Headlights

Automatic on/off headlights that sense when light is needed.

### Available RearView Monitor<sup>2</sup>

### Available Rear Sonar System<sup>3</sup>

## RESPOND

Whether you need to hit the brakes hard or maneuver around an unexpected obstacle, these standard technologies help you respond to a potentially harmful situation.

**Vehicle Dynamic Control** helps you maintain your steered path.<sup>4</sup>

**Traction Control System** helps reduce wheelspin in low-traction situations.

**Anti-lock Braking System** helps you maintain steering control around obstacles while braking heavily.

**Electronic Brake force Distribution** sends extra force to the rear brakes when you have additional weight of passengers or cargo in the back.

**Brake Assist** helps apply maximum braking force if it detects hard braking and senses you are in an emergency situation.<sup>5</sup>

## PROTECT

When a collision is unavoidable, Nissan's Zone Body construction helps absorb the impact while the advanced seat belt and air bag systems help protect you and your passengers.

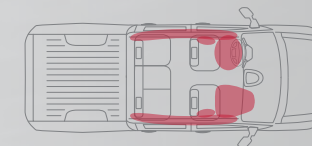

**6 Standard Airbags<sup>6</sup>** Nissan Advanced Air Bag System with dual-stage supplemental front air bags with seat belt and occupant-classification sensors.<sup>6</sup> Also featured, front seat-mounted side-impact supplemental air bags,<sup>6</sup> roof-mounted curtain side-impact supplemental air bags,<sup>6</sup> with rollover sensor.



**Available RearView Monitor.** Helps you see what's directly behind you, so you can back up with more confidence and park more easily.<sup>2</sup>



Nissan safety engineers have dedicated thousands of hours to evaluating hundreds of child restraints in Nissans. The result: An industry first, The Snug Kids® Child Safety Seat Fit Guide. This guide lists child seats that fit the rear seats of Nissan vehicles, as well as offers invaluable tips on correct installation. Look for the latest Fit Guide at [NissanUSA.com/SnugKids](http://NissanUSA.com/SnugKids). Looking for the right CRS for your Nissan? See how Snug Kids® can help at [bit.ly/NissanSnugKids](http://bit.ly/NissanSnugKids)



Looking for the right CRS for your Nissan? Click here to watch this video. Or go to [bit.ly/NissanSnugKids](http://bit.ly/NissanSnugKids)

<sup>1</sup>TPMS is not a substitute for regular tire pressure checks. <sup>2</sup>Parking aid/convenience feature. Cannot completely eliminate blind spots. May not detect every object and does not warn of moving objects. Always check surroundings and turn to look behind you before moving vehicle. <sup>3</sup>The Sonar System is a convenience, not a substitute for proper parking and/or backing procedures. Always check that it is safe to do so before moving vehicle. May not detect every object. <sup>4</sup>VDC, which should remain on when driving except when freeing the vehicle from mud or snow, cannot prevent accidents due to abrupt steering, carelessness, or dangerous driving techniques. <sup>5</sup>Brake Assist is only an aid to assist the driver and is not a collision warning or avoidance device. It is the driver's responsibility to be in control of the vehicle at all times. <sup>6</sup>Air bags are only a supplemental restraint system; always wear your seat belt. Even with the occupant-classification sensor, rear-facing child restraints should not be placed in the front-passenger's seat. All children 12 and under should ride in the rear seat properly secured in child restraints, booster seats, or seat belts according to their size. Air bags will only inflate in certain accidents; see your Owner's Manual for more details. Inflated air bags shown for illustration purposes only, actual coverage area may differ. Air bags deflate after deployment.



## GENUINE NISSAN ACCESSORIES.

Every Genuine Nissan Accessory is custom-fit, custom-designed and durability-tested. Each one is backed by Nissan's 3-year/36,000-mile (whichever occurs first) limited warranty (if installed by dealer at the time of purchase); and can be financed when installed by dealer at time of purchase.

- A. **Sliding Bed Extender<sup>2</sup>**  
Ideal for the long haul.
- B. **Chrome Taillight Guards**  
Protect taillights with a custom feel.
- C. **Auto-dimming Rearview Mirror with HomeLink<sup>®</sup> and Compass**  
How many things can one mirror do?
- D. **Sliding Bed Divider<sup>2</sup>**  
Divide and conquer. Works perfectly with Utili-track<sup>®</sup> system.
- E. **Stainless Steel Exhaust Finisher**  
Helps your Titan<sup>®</sup> look as sweet as it sounds.
- F. **PRO-4X<sup>®</sup> Carpeted Floor Mats**  
Keep your original carpeting looking showroom new.
- G. **U-shape Side Steps**  
Easy entry and exit – and a tough look.
- H. **Moonroof Wind Deflector**  
Open air is good. Wind-blown pompadour look – not so much.

<sup>1</sup>Genuine Nissan Accessories are covered by Nissan's Limited Warranty on Genuine Nissan Replacement Parts, Genuine NISMO<sup>®</sup> S-Tune Parts, and Genuine Nissan Accessories for the longer of 12 months/12,000 miles (whichever occurs first) or the remaining period under the 3-year/36,000-mile (whichever occurs first) Nissan New Vehicle Limited Warranty. Terms and conditions apply. See Warranty Information Booklet for details. <sup>2</sup>Cargo shown for display purposes only. Cargo and load capacity limited by weight and distribution. Always secure all cargo. HomeLink<sup>®</sup> is a registered trademark of Johnson Controls Technology Company.

Click the button to see short videos on Genuine Nissan Accessories in action. Or go to [bit.ly/titan\\_gnavideos](http://bit.ly/titan_gnavideos)



# LET THEM KNOW YOU'RE SERIOUS.

For more information and to shop online for Genuine Nissan Accessories, go to [bit.ly/titan\\_estore](http://bit.ly/titan_estore)



**Nissan Titan<sup>®</sup> SL Crew Cab** shown in Gun Metallic with 20" Chrome Wheels, Chrome Billet Grille, Chrome-finished Hood Protector, Chrome Step Rails (standard on SL), Chrome Bed Tube Rails, Telescoping Tow Mirrors, and Splash Guards.



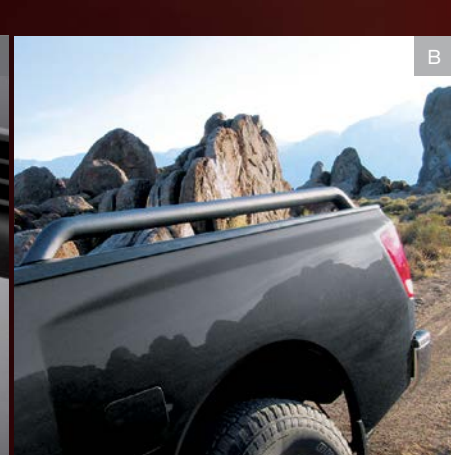

Along with the other hard-working accessories listed below, you'll find a full line of accessories designed specifically to work with the unique system of channels and cleats in Titan's incredibly versatile Utili-track® system.<sup>1</sup>

**A. Tow Hitch Receiver, Class IV and Trailer Tow Harness (7-pin)<sup>2</sup>**  
Give the boat a ride, too.

**B. Charcoal Bed Tube Rails**  
More tie-down points equals more security.

**C. NISMO® Cat-back Exhaust System<sup>3</sup>**  
More horsepower, more torque, and more aggressive sound.

**D. Sliding Tool Box**  
Slide it forward when you're on the move.  
Slide it back for easy access on the job.

**E. Bed Tent**  
It's your Titan®! It's your campsite! It's both!

**F. Telescoping Tow Mirrors<sup>2</sup>**  
Get a fresh perspective with mirrors that slide outward for improved visibility while towing.

**G. Rear Bumper Step-up Assist**  
Easy access? Step right up!

**H. All-season Floor Mats**  
Don't let the muck mess up your truck.



Click the button to see short videos on Genuine Nissan Accessories in action. Or go to [bit.ly/titan\\_gnavideos](http://bit.ly/titan_gnavideos)



For more information and to shop online for Titan® Genuine Nissan Accessories, go to [bit.ly/titan\\_estore](http://bit.ly/titan_estore)

<sup>1</sup>Cargo shown for display purposes only. Cargo and load capacity limited by weight and distribution. Always secure all cargo. <sup>2</sup>See Nissan Towing Guide and Owner's Manual for proper use. <sup>3</sup>NISMO® S-Tune accessories are covered by Nissan's Limited Warranty on Genuine Nissan Replacement Parts, Genuine NISMO® S-Tune Parts, and Genuine Nissan Accessories for the longer of 12 months/12,000 miles (whichever occurs first) or the remaining period under the 3-year/36,000-mile (whichever occurs first) Nissan New Vehicle Limited Warranty. Terms and conditions apply. See Warranty Information Booklet for details.

**Nissan Titan® SL Crew Cab with optional Moonroof Package** shown in Gun Metallic with 20" Chrome Wheels, Chrome Step Rails (standard on SL), Telescoping Tow Mirrors, Splash Guards, Sliding Tool Box, Sliding Bed Extender, Chrome Taillight Guards, and Rear Bumper Step-up Assist.

## CHOOSE YOUR TRIM LEVEL

**S** KING CAB® CREW CAB

- 5.6-liter Endurance V8 engine
- 5-speed automatic transmission with Tow/Haul Mode
- 4-wheel Anti-lock Braking System (ABS)
- 18" Painted steel wheels with P265/70R18 tires
- Air conditioning
- 6-passenger capacity
- 40/20/40 Split front bench seat
- 60/40 Split fold-up rear bench seat

- AM/FM/CD audio system
- Six standard air bags
- Vehicle Dynamic Control (VDC)
- Rear tailgate spoiler

**Crew Cab adds:<sup>1</sup>**

- Power windows, including back glass window
- Rear privacy glass
- Power door locks with auto-locking feature
- Rear reading lights

**KEY AVAILABLE PACKAGE:**

- Popular Equipment Package



**SV** KING CAB® CREW CAB

**Includes S equipment plus:**

- 18" Aluminum-alloy wheels with P265/70R18 tires
- Chrome bumpers and grille
- Body side moldings
- Step rails

- Remote keyless entry with power door locks and windows
- Power outside mirrors
- Cruise control
- Sun visors with illuminated vanity mirrors
- Vehicle Security System and Nissan Vehicle Immobilizer System

**KEY AVAILABLE PACKAGES:**

- Value Truck Package
- Utility Package
- Premium Utility Package



**PRO-4X®** KING CAB® CREW CAB

**Includes SV 4x4 equipment plus:<sup>2</sup>**

- Dark-finished 18" aluminum-alloy wheels
- BFGoodrich® Rugged Trail T/A® tires
- Satin chrome-finished front grille
- Body-color bumpers
- Automatic on/off headlights and fog lights
- PRO-4X® off-road bedside graphics
- Rancho® shock absorbers
- Lower final gear ratio (3.36:1)
- Transfer case and lower radiator skid plates
- Electronic locking rear differential
- Lockable bedside storage

- Rear Sonar System
- Class IV tow hitch receiver
- NissanConnect<sup>SM</sup> with Mobile Apps
- RearView Monitor with 5" color display
- SiriusXM Satellite Radio<sup>3</sup>
- Bluetooth® Hands-free Phone System<sup>4</sup>
- USB connection port for iPod®
- Center console-mounted 120-volt AC power outlet
- Unique PRO-4X® interior trim
- White-faced gauges
- Front captain's chairs with center console

**KEY AVAILABLE PACKAGES:**

- Premium Utility Package
- Luxury Package
- Moonroof Package
- DVD Package

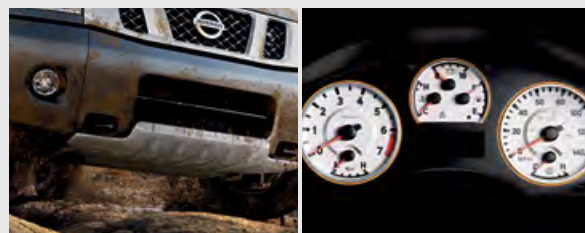

**SL** CREW CAB

**Includes SV equipment plus:**

- 20" Aluminum-alloy wheels with P275/60R20 tires
- Automatic on/off headlights and fog lights
- Chrome step rails
- Utili-track® Channel System and spray-on bedliner
- Lockable bedside storage
- Two 120-volt AC power outlets (bed and center console)
- NissanConnect<sup>SM</sup> with Navigation and Mobile Apps
- RearView Monitor

- Rockford Fosgate®-powered audio system
- SiriusXM® Traffic and Travel Link<sup>®3</sup>
- SiriusXM® Satellite Radio<sup>3</sup>
- Bluetooth® Hands-free Phone System<sup>4</sup>
- USB connection port for iPod®
- Dual Zone Automatic Temperature Control (ATC)
- Leather-appointed seats
- Heated front captain's chairs with Driver's Memory System
- HomeLink® Universal Transceiver
- Rear Sonar System and Class IV tow hitch receiver

**KEY AVAILABLE PACKAGES:**

- Max Utility Package
- Moonroof Package
- DVD Package



## CHOOSE A PACKAGE

**SV - VALUE TRUCK PACKAGE** CREW CAB

**Includes S equipment plus:**

- 20" Dark Hyper Silver-finished aluminum-alloy wheels with P275/60R20 tires
- Fog lights
- Black step rails
- Black wheel arch moldings
- Front captain's chairs with lockable center console
- 8-way power adjustable driver's seat
- Leather-wrapped steering wheel with audio controls

- NissanConnect<sup>SM</sup> with Navigation and Mobile Apps
- RearView Monitor
- Rockford Fosgate®-powered audio system
- Center console-mounted 120-volt AC power outlet
- Rear air conditioning vents (Crew Cab only)
- Lockable bedside storage
- Rear Sonar System
- Class IV tow hitch receiver

See Specifications for a complete list of features.



**SV/SL HEAVY METAL EDITION®** CREW CAB

**SV Crew Cab**

- 18" Chrome-clad alloy wheels
- Chrome outside mirrors and door handles
- Chrome billet grille
- Chrome step rails
- Heavy Metal Edition® fender badging

**SL Crew Cab**

- 20" Chrome alloy wheels
- Chrome billet grille
- Heavy Metal Edition® fender badging



<sup>1</sup>See Specifications for a complete list of exclusive Crew Cab equipment. <sup>2</sup>Excludes step rails. <sup>3</sup>Required SiriusXM® Satellite Radio, SiriusXM® Traffic and SiriusXM® Travel Link® services subscriptions sold separately and are continuous until you call SiriusXM to cancel. Installation costs, one-time activation fee, other fees and taxes will apply. SiriusXM® Travel Link® services available in select markets. Satellite Radio U.S. service, SiriusXM® Traffic and SiriusXM® Travel Link Services® available only to those 18 or older in the 48 contiguous states and D.C. Fees and programming subject to change. Subscriptions governed by Customer Agreement available at [siriusxm.com](http://siriusxm.com). ©2014 Sirius XM Radio Inc. Sirius® XM® and all related marks and logos are trademarks of Sirius XM Radio Inc. <sup>4</sup>Availability of specific features is dependent upon the phone's Bluetooth® support. Please refer to your phone Owner's Manual for details. Bluetooth® word mark and logos are owned by Bluetooth SIG, Inc., and any use of such marks by Nissan is under license. BFGoodrich® is a registered trademark of Goodrich Corporation. Google® is a registered trademark of Google Inc. HomeLink® is a registered trademark of Johnson Controls Technology Company. iPod® is a registered trademark of Apple, Inc. All rights reserved. iPod® not included. Pandora® is a registered trademark of Pandora Media. Rancho® is a registered trademark of Tenneco Automotive Operating Company, Inc. Rockford Fosgate® is a registered trademark of Rockford Corporation. Rugged Trail T/A® is a registered trademark of Uniroyal Goodrich Licensing Services, Inc.

# CHOOSE YOUR COLOR



You've decided which Titan® you want, now here comes the best part: deciding what it's going to look like. Choose your favorite color and then pick from the available interiors based on the model of your choice.

- Standard
- Part of Leather Package

Nissan has taken care to ensure that the digital color swatches presented here are the closest possible representation of actual vehicle colors. Swatches may vary slightly due to viewing light or screen quality. Please see the actual vehicle and colors at your local Nissan dealer.

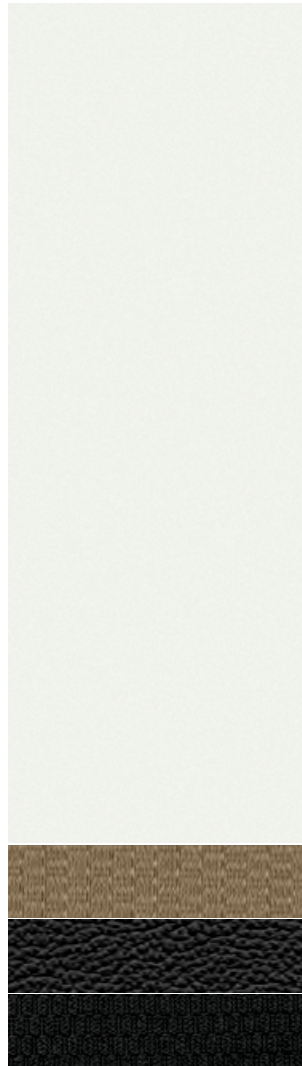

Glacier White QAK

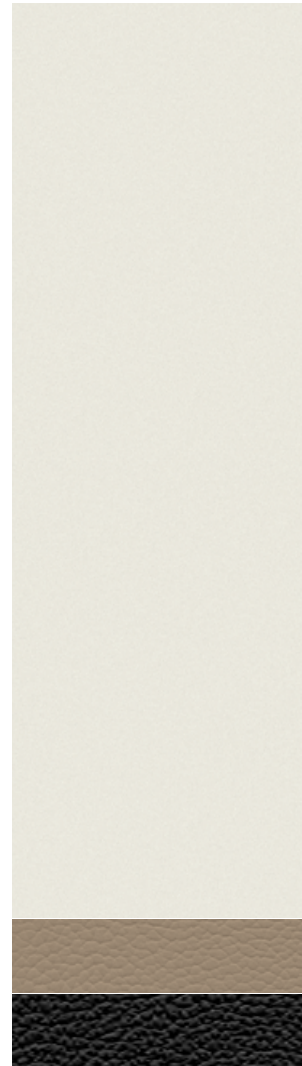

Pearl White QAB¹



Brilliant Silver K23



Gun Metallic KAD



Cayenne Red NAH



Arctic Blue Metallic RBG

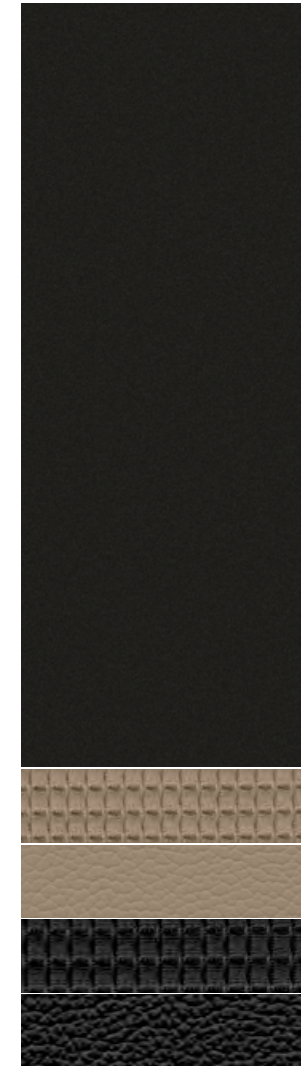

Magnetic Black G41



Espresso Black CAE



Java Metallic CAJ

	S	SV	PRO-4X®	SL
ALMOND CLOTH		<input type="checkbox"/>		
ALMOND LEATHER				<input type="checkbox"/>
CHARCOAL CLOTH	<input type="checkbox"/>	<input type="checkbox"/>	<input type="checkbox"/>	
CHARCOAL LEATHER			<input type="checkbox"/>	<input type="checkbox"/>

¹Extra cost option.

CHOOSE YOUR FABRIC

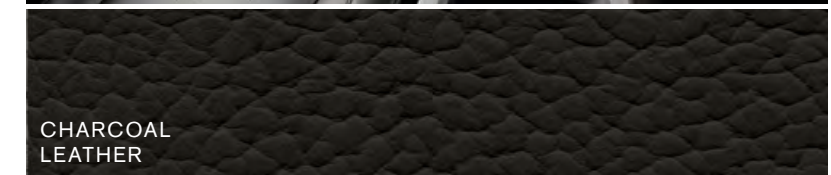

## SPECIFICATIONS

Engine	S	SV	PRO-4X <sup>1</sup>	SL
VK56DE – Endurance 5.6-liter DOHC 32-valve V8 engine	<input checked="" type="checkbox"/>	<input checked="" type="checkbox"/>	<input checked="" type="checkbox"/>	<input checked="" type="checkbox"/>
Horsepower – 317 hp @ 5,200 rpm				
Torque – 385 lb-ft @ 3,400 rpm				
Continuously Variable Valve Timing Control System (CVTCS)	<input checked="" type="checkbox"/>	<input checked="" type="checkbox"/>	<input checked="" type="checkbox"/>	<input checked="" type="checkbox"/>
Electronic drive-by-wire throttle	<input checked="" type="checkbox"/>	<input checked="" type="checkbox"/>	<input checked="" type="checkbox"/>	<input checked="" type="checkbox"/>
Alternator (130 amps)	<input checked="" type="checkbox"/>	<input checked="" type="checkbox"/>	<input checked="" type="checkbox"/>	<input checked="" type="checkbox"/>
Heavy-duty battery (710 CCA) – standard on all FFV models			<input checked="" type="checkbox"/>	<input checked="" type="checkbox"/>
Flexible Fuel Vehicle (FFV) <sup>1</sup>	<input type="checkbox"/>	<input type="checkbox"/>	<input type="checkbox"/>	<input type="checkbox"/>

Drivetrain	S	SV	PRO-4X <sup>1</sup>	SL
5-speed automatic transmission with Tow/Haul Mode	<input checked="" type="checkbox"/>	<input checked="" type="checkbox"/>	<input checked="" type="checkbox"/>	<input checked="" type="checkbox"/>
Final gear ratio (2.94:1 – similar to a 4-speed automatic 3.73:1)	<input checked="" type="checkbox"/>	<input checked="" type="checkbox"/>		<input checked="" type="checkbox"/>
Lower final gear ratio (3.36:1 – similar to a 4-speed automatic 4.10:1)		<input checked="" type="checkbox"/>	<input checked="" type="checkbox"/>	<input checked="" type="checkbox"/>
Switch-operated 2-speed transfer case 4WD (4H – 1.000; 4LO – 2.596)	<input type="checkbox"/>	<input type="checkbox"/>	<input checked="" type="checkbox"/>	<input type="checkbox"/>
Electronic locking rear differential			<input checked="" type="checkbox"/>	

Brakes	S	SV	PRO-4X <sup>1</sup>	SL
Front vented disc/rear vented disc brake	<input checked="" type="checkbox"/>	<input checked="" type="checkbox"/>	<input checked="" type="checkbox"/>	<input checked="" type="checkbox"/>
4-wheel Anti-lock Braking System (ABS)	<input checked="" type="checkbox"/>	<input checked="" type="checkbox"/>	<input checked="" type="checkbox"/>	<input checked="" type="checkbox"/>
Electronic Brake force Distribution (EBD) and Brake Assist	<input checked="" type="checkbox"/>	<input checked="" type="checkbox"/>	<input checked="" type="checkbox"/>	<input checked="" type="checkbox"/>

Suspension/Steering	S	SV	PRO-4X <sup>1</sup>	SL
Independent double-wishbone front suspension with stabilizer bar (Dana <sup>®</sup> axles on 4x4 models)	<input checked="" type="checkbox"/>	<input checked="" type="checkbox"/>	<input checked="" type="checkbox"/>	<input checked="" type="checkbox"/>
Multi-leaf rear suspension with solid Dana <sup>®</sup> axle	<input checked="" type="checkbox"/>	<input checked="" type="checkbox"/>	<input checked="" type="checkbox"/>	<input checked="" type="checkbox"/>
Rancho <sup>®</sup> off-road performance shocks			<input checked="" type="checkbox"/>	
Engine-speed-sensitive power steering	<input checked="" type="checkbox"/>	<input checked="" type="checkbox"/>	<input checked="" type="checkbox"/>	<input checked="" type="checkbox"/>

Wheels/Tires	S	SV	PRO-4X <sup>1</sup>	SL
18" x 8.0" painted steel wheels	<input checked="" type="checkbox"/>			
18" x 8.0" aluminum-alloy wheels	<input checked="" type="checkbox"/>	<input checked="" type="checkbox"/>		
18" x 8.0" chrome-clad alloy wheels		<input checked="" type="checkbox"/>		

Standard

Optional

Part of S Popular Equipment Package

Part of SV Value Truck Package

Part of SV Utility Package

Part of SV Premium Utility Package

Part of PRO-4X<sup>®</sup> Premium Utility Package

Part of PRO-4X<sup>®</sup> Luxury Package

Wheels/Tires (continued)	S	SV	PRO-4X <sup>1</sup>	SL
18" x 8.0" unique dark-finished aluminum-alloy wheels			<input checked="" type="checkbox"/>	
20" x 8.0" aluminum-alloy wheels				<input checked="" type="checkbox"/>
20" x 8.0" Dark Hyper Silver-finished aluminum-alloy wheels		<input checked="" type="checkbox"/>		
20" x 8.0" chrome alloy wheels				<input checked="" type="checkbox"/>
P265/70R18 tires	<input checked="" type="checkbox"/>			
P265/70R18 Goodyear <sup>®</sup> Wrangler <sup>®</sup> tires with raised outlined white lettering		<input checked="" type="checkbox"/>		
P275/70R18 BFGoodrich <sup>®</sup> Rugged Trail <sup>®</sup> tires with raised outlined white lettering			<input checked="" type="checkbox"/>	
P275/60R20 Goodyear <sup>®</sup> Wrangler <sup>®</sup> tires		<input checked="" type="checkbox"/>		<input checked="" type="checkbox"/>

Exterior Features	S	SV	PRO-4X <sup>1</sup>	SL
Oil pan and fuel tank skid plates (4x4 models)	<input checked="" type="checkbox"/>	<input checked="" type="checkbox"/>	<input checked="" type="checkbox"/>	<input checked="" type="checkbox"/>
Transfer case and lower radiator skid plates			<input checked="" type="checkbox"/>	
Body-color bumpers			<input checked="" type="checkbox"/>	
Chrome bumpers and grille		<input checked="" type="checkbox"/>		<input checked="" type="checkbox"/>
Satin chrome-finished front grille			<input checked="" type="checkbox"/>	
Chrome billet grille		<input checked="" type="checkbox"/>		<input checked="" type="checkbox"/>
Dual power outside mirrors		<input checked="" type="checkbox"/>	<input checked="" type="checkbox"/>	
Chrome outside mirrors		<input checked="" type="checkbox"/>		<input checked="" type="checkbox"/>
Heated outside mirrors				<input checked="" type="checkbox"/>
Dual chrome power folding auto-dimming outside mirrors with puddle lights and turn signals				<input checked="" type="checkbox"/>
Power heated extendable tow mirrors		<input checked="" type="checkbox"/>	<input checked="" type="checkbox"/>	<input checked="" type="checkbox"/>
Black door handles	<input checked="" type="checkbox"/>	<input checked="" type="checkbox"/>	<input checked="" type="checkbox"/>	
Chrome door handles		<input checked="" type="checkbox"/>		<input checked="" type="checkbox"/>
Class IV tow hitch receiver	<input checked="" type="checkbox"/>	<input checked="" type="checkbox"/>	<input checked="" type="checkbox"/>	<input checked="" type="checkbox"/>
Step rails		<input checked="" type="checkbox"/>		
Chrome step rails		<input checked="" type="checkbox"/>		<input checked="" type="checkbox"/>
Automatic on/off headlights			<input checked="" type="checkbox"/>	<input checked="" type="checkbox"/>
Fog lights		<input checked="" type="checkbox"/>	<input checked="" type="checkbox"/>	<input checked="" type="checkbox"/>
Front tow hooks (standard on SV 4x4 and SL 4x4)		<input checked="" type="checkbox"/>	<input checked="" type="checkbox"/>	<input checked="" type="checkbox"/>
Body side moldings		<input checked="" type="checkbox"/>	<input checked="" type="checkbox"/>	<input checked="" type="checkbox"/>
Black wheel arch moldings (body-color on SL)		<input checked="" type="checkbox"/>	<input checked="" type="checkbox"/>	<input checked="" type="checkbox"/>

Part of SL Max Utility Package

Part of DVD Package (PRO-4X<sup>®</sup> and SL Crew Cab)

Part of Moonroof Package (PRO-4X<sup>®</sup> and SL Crew Cab)

Part of Heavy Metal Edition<sup>®</sup> (SV and SL Crew Cab)

Exterior Features (continued)	S	SV	PRO-4X <sup>1</sup>	SL
Splash guards			<input checked="" type="checkbox"/>	
Power sliding glass moonroof (Crew Cab only)			<input checked="" type="checkbox"/>	<input checked="" type="checkbox"/>
Sliding back window and privacy glass (King Cab <sup>®</sup> only)	<input checked="" type="checkbox"/>	<input checked="" type="checkbox"/>	<input checked="" type="checkbox"/>	<input checked="" type="checkbox"/>
Power back window (Crew Cab only)	<input checked="" type="checkbox"/>	<input checked="" type="checkbox"/>	<input checked="" type="checkbox"/>	<input checked="" type="checkbox"/>
Rear privacy glass (standard on S Crew Cab)	<input checked="" type="checkbox"/>	<input checked="" type="checkbox"/>	<input checked="" type="checkbox"/>	<input checked="" type="checkbox"/>
Rear Sonar System		<input checked="" type="checkbox"/>	<input checked="" type="checkbox"/>	<input checked="" type="checkbox"/>
Rear spoiler	<input checked="" type="checkbox"/>	<input checked="" type="checkbox"/>	<input checked="" type="checkbox"/>	<input checked="" type="checkbox"/>
Utili-track <sup>®</sup> Channel System with 4 tie-down cleats		<input checked="" type="checkbox"/>	<input checked="" type="checkbox"/>	<input checked="" type="checkbox"/>
Factory-applied spray-on bedliner		<input checked="" type="checkbox"/>	<input checked="" type="checkbox"/>	<input checked="" type="checkbox"/>
Lockable bedside storage		<input checked="" type="checkbox"/>	<input checked="" type="checkbox"/>	<input checked="" type="checkbox"/>
Tailgate area illumination		<input checked="" type="checkbox"/>	<input checked="" type="checkbox"/>	<input checked="" type="checkbox"/>
Bed-mounted 120-volt AC power outlet		<input checked="" type="checkbox"/>	<input checked="" type="checkbox"/>	<input checked="" type="checkbox"/>
Locking dampened-assist tailgate		<input checked="" type="checkbox"/>	<input checked="" type="checkbox"/>	<input checked="" type="checkbox"/>
Cargo bed light	<input checked="" type="checkbox"/>	<input checked="" type="checkbox"/>	<input checked="" type="checkbox"/>	<input checked="" type="checkbox"/>

Comfort/Convenience	S	SV	PRO-4X <sup>1</sup>	SL
Nissan Navigation System with 5.8" color touch-screen monitor and Voice Recognition <sup>2</sup>		<input checked="" type="checkbox"/>	<input checked="" type="checkbox"/>	<input checked="" type="checkbox"/>
SiriusXM <sup>®</sup> Traffic and Travel Link <sup>®3</sup>		<input checked="" type="checkbox"/>	<input checked="" type="checkbox"/>	<input checked="" type="checkbox"/>
NissanConnect <sup>SM</sup> with Mobile Apps <sup>4</sup>		<input checked="" type="checkbox"/>	<input checked="" type="checkbox"/>	<input checked="" type="checkbox"/>
Hands-free text messaging assistant <sup>5</sup>		<input checked="" type="checkbox"/>	<input checked="" type="checkbox"/>	<input checked="" type="checkbox"/>
RearView Monitor		<input checked="" type="checkbox"/>	<input checked="" type="checkbox"/>	<input checked="" type="checkbox"/>
Bluetooth <sup>®</sup> Hands-free Phone System <sup>6</sup>		<input checked="" type="checkbox"/>	<input checked="" type="checkbox"/>	<input checked="" type="checkbox"/>
Air conditioning	<input checked="" type="checkbox"/>	<input checked="" type="checkbox"/>	<input checked="" type="checkbox"/>	
Dual Zone Automatic Temperature Control (ATC)				<input checked="" type="checkbox"/>
In-cabin microfilter (Crew Cab only)			<input checked="" type="checkbox"/>	<input checked="" type="checkbox"/>
Rear air conditioning vents (Crew Cab only)		<input checked="" type="checkbox"/>	<input checked="" type="checkbox"/>	<input checked="" type="checkbox"/>
Power front windows (front and rear on Crew Cab)	<input checked="" type="checkbox"/>	<input checked="" type="checkbox"/>	<input checked="" type="checkbox"/>	<input checked="" type="checkbox"/>
Power door locks with auto-locking feature	<input checked="" type="checkbox"/>	<input checked="" type="checkbox"/>	<input checked="" type="checkbox"/>	<input checked="" type="checkbox"/>
Remote keyless entry with remote windows down (not available on S King Cab <sup>®</sup> )	<input checked="" type="checkbox"/>	<input checked="" type="checkbox"/>	<input checked="" type="checkbox"/>	<input checked="" type="checkbox"/>
HomeLink <sup>®</sup> Universal Transceiver		<input checked="" type="checkbox"/>	<input checked="" type="checkbox"/>	<input checked="" type="checkbox"/>
Cruise control with steering wheel-mounted controls	<input checked="" type="checkbox"/>	<input checked="" type="checkbox"/>	<input checked="" type="checkbox"/>	<input checked="" type="checkbox"/>
Variable intermittent windshield wipers	<input checked="" type="checkbox"/>	<input checked="" type="checkbox"/>	<input checked="" type="checkbox"/>	<input checked="" type="checkbox"/>
Door courtesy lights		<input checked="" type="checkbox"/>	<input checked="" type="checkbox"/>	<input checked="" type="checkbox"/>
Auto-dimming rearview mirror with digital compass		<input checked="" type="checkbox"/>	<input checked="" type="checkbox"/>	<input checked="" type="checkbox"/>
Multi-Function Display system		<input checked="" type="checkbox"/>	<input checked="" type="checkbox"/>	<input checked="" type="checkbox"/>
Sun visors with illuminated vanity mirrors and extension		<input checked="" type="checkbox"/>	<input checked="" type="checkbox"/>	<input checked="" type="checkbox"/>

<sup>1</sup>Available in North Central, South Central, Southeast and Mid-Atlantic regions only. <sup>2</sup>Never program while driving. GPS mapping may not be detailed in all areas or reflect current road status. <sup>3</sup>Required SiriusXM<sup>®</sup> Satellite Radio, SiriusXM<sup>®</sup> Traffic and SiriusXM<sup>®</sup> Travel Link<sup>®</sup> services subscriptions sold separately and are continuous until you call SiriusXM to cancel. Installation costs, one-time activation fee, other fees and taxes will apply. SiriusXM<sup>®</sup> Travel Link<sup>®</sup> services available in select markets. Satellite Radio U.S. service, SiriusXM<sup>®</sup> Traffic and SiriusXM<sup>®</sup> Travel Link Services<sup>®</sup> available only to those 18 or older in the 48 contiguous states and D.C. Fees and programming subject to change. Subscriptions governed by Customer Agreement available at [siriusxm.com](http://siriusxm.com). ©2014 Sirius XM Radio Inc. Sirius<sup>®</sup> XM<sup>®</sup> and all related marks and logos are trademarks of Sirius XM Radio Inc. <sup>4</sup>Driving is serious business. Only use NissanConnect<sup>™</sup> services when safe to do so. Subscription Agreement required. Compatible smartphone required. Not all app features are available for all models. Some apps have late availability. May require dealer service visit or software upgrade to activate. Never program while driving. GPS mapping may not be detailed in all areas or reflect current road status. Cellular network not available in all areas. Cellular network, apps, and services, including Google<sup>®</sup> services, are provided by independent companies not within Nissan's control and may require subscription and owner consent to activate. Should provider terminate/restrict service, service may be terminated without notice or liability to Nissan and/or its agents. Nissan not responsible for any equipment or app replacement/upgrades, or associated costs, that may be required for continued operation. Terms and conditions of Subscription Agreement apply. 36-month trial period starts on vehicle sale date; subsequently a paid subscription is required at the then current rate (excludes Pandora<sup>®</sup>). Standard text rates and/or data usage may apply. See retailer and check [www.NissanUSA.com/connect](http://www.NissanUSA.com/connect) for details. <sup>5</sup>Use the text messaging feature after stopping your vehicle in a safe location. If you have to use the feature while driving, exercise extreme caution at all times so full attention may be given to vehicle operation. Compatible smartphone required. Standard text rates and/or data usage may apply. <sup>6</sup>Availability of specific features is dependent upon the phone's Bluetooth<sup>®</sup> support. Please refer to your phone Owner's Manual for details. Bluetooth<sup>®</sup> word mark and logos are owned by Bluetooth SIG, Inc., and any use of such marks by Nissan is under license. <sup>7</sup>Manual windows and door locks on King Cab<sup>®</sup> models. BFGoodrich<sup>®</sup> is a registered trademark of Goodrich Corporation. Dana<sup>®</sup> is a registered trademark of Dana Corporation. Goodyear<sup>®</sup> and Wrangler are registered trademarks of The Goodyear Tire & Rubber Company. HomeLink<sup>®</sup> is a registered trademark of Johnson Controls Technology Company. Rancho<sup>®</sup> is a registered trademark of Tenneco Automotive Operating Company, Inc. Rugged Trail<sup>®</sup> is a registered trademark of Uniroyal Goodrich Licensing Services, Inc.

## SPECIFICATIONS (CONTINUED)

Comfort/Convenience (continued)	S	SV	PRO-4X <sup>1</sup>	SL
Power adjustable pedals		P1	P2	
Center console-mounted 120-volt AC power outlet		VT		
Overhead center console	PE			
Extended overhead center console (Crew Cab only)			P2	
Rear reading lights (Crew Cab only)				
Easy Clean <sup>®</sup> vinyl flooring (King Cab <sup>®</sup> only)				
Carpeted floor mats		VT		

Seating/Appointments	S	SV	PRO-4X <sup>1</sup>	SL
40/20/40 Split bench front seat with column shifter				
Front captain's chairs with lockable center console		VT		
8-way power adjustable driver's seat with power lumbar		VT		
4-way power adjustable passenger's seat			L	
Heated front seats			L	
60/40 Split flip-up rear bench seat				
Memory System – driver's seat, outside mirrors and pedals (two settings)			L	
Cloth seat trim				
Titan <sup>®</sup> embroidered two-tone cloth seat trim with white stitching				
PRO-4X <sup>®</sup> embroidered leather-appointed seats with white stitching			L	
Leather-appointed seats				
Leather-wrapped steering wheel		VT		
Leather-wrapped floor-mounted transmission shifter		VT		
Piano black interior accents				
Bright silver and piano black interior accents				
Wood-tone trim				
White-faced gauges				

Audio/Entertainment	S	SV	PRO-4X <sup>1</sup>	SL
Nissan Mobile Entertainment System with 8" flip-down monitor, DVD player with remote control and two wireless headsets (Crew Cab only)			D	D
AM/FM/CD audio system				
AM/FM/CD audio system with 5" color display				
Rockford Fosgate <sup>®</sup> -powered AM/FM/CD audio system		VT	P2	

Audio/Entertainment (continued)	S	SV	PRO-4X <sup>1</sup>	SL
SiriusXM <sup>®</sup> Satellite Radio <sup>1</sup>		VT		
Streaming audio via Bluetooth <sup>®</sup> wireless technology <sup>2</sup>				
MP3/WMA CD playback capability				
Dual Media Playback (Crew Cab only)		P1		
Radio Data System (RDS)				
Auxiliary audio input jack				
USB connection port for iPod <sup>®</sup> interface and other compatible devices		VT		
Steering wheel-mounted audio controls		VT		
Six speakers (eight speakers on Crew Cab)				
Eight speakers, including woofer and center speaker (ten speakers on Crew Cab)		P1	P2	

Safety/Security	S	SV	PRO-4X <sup>1</sup>	SL
Nissan Advanced Air Bag System with dual-stage supplemental front air bags with seat belt and occupant-classification sensors				
Driver and front-passenger seat-mounted side-impact supplemental air bags				
Roof-mounted curtain supplemental air bags for side-impact and rollover head protection for front and rear outboard occupants				
Vehicle Dynamic Control (VDC) with Traction Control System (TCS)				
Active Brake Limited Slip (ABLS)				
Front-seat Active Head Restraint				
3-point ALR/ELR passenger seat belt system (ELR for driver)				
Front seat belts with pretensioners and load limiters				
LATCH System (Lower Anchors and Tethers for CHildren)				
Zone Body construction with front and rear crumple zones				
Hood-buckling creases				
Energy-absorbing steering column				
Pipe-style steel side-door guard beams				
Tire Pressure Monitoring System (TPMS)				
Vehicle Security System				
Nissan Vehicle Immobilizer System				

## PACKAGES

### PE S Popular Equipment Package

- 18" Aluminum-alloy wheels
- Overhead center console
- Cruise control with steering wheel-mounted controls
- Sliding back window and rear privacy glass (King Cab<sup>®</sup> only)
- Remote keyless entry (Crew Cab only)
- Class IV tow hitch receiver and 7-pin wiring harness
- Trailer brake controller pre-wiring under instrument panel

### VT SV Value Truck Package

- 20" Dark Hyper Silver-finished aluminum-alloy wheels with P275/60R20 tires
- Fog lights
- Black step rails
- Front captain's chairs with floor shifter and center console
- 8-way power adjustable driver's seat with power lumbar
- Leather-wrapped steering wheel
- Steering wheel-mounted audio controls
- RearView Monitor
- Nissan Navigation System with 5.8" color touch-screen monitor and Voice Recognition<sup>3</sup>
- NissanConnect<sup>SM</sup> with Mobile Apps<sup>4</sup>
- Rockford Fosgate<sup>®</sup>-powered audio system plus two speakers
- SiriusXM<sup>®</sup> Satellite Radio, SiriusXM<sup>®</sup> Traffic and Travel Link<sup>®1</sup>
- Bluetooth<sup>®</sup> Hands-free Phone System<sup>2</sup>
- Streaming audio via Bluetooth<sup>®</sup> wireless technology<sup>2</sup>
- USB connection port for iPod<sup>®</sup> interface and other compatible devices
- Auto-dimming rearview mirror with digital compass
- Center console-mounted 120-volt AC power outlet
- Rear air conditioning vents (Crew Cab only)
- Carpeted floor mats
- Lockable bedside storage
- Black wheel arch moldings
- Rear Sonar System
- Class IV tow hitch receiver and 7-pin wiring harness
- Trailer brake controller pre-wiring under instrument panel

### U SV Utility Package

- Utili-track<sup>®</sup> Channel System with four tie-down cleats
  - Factory-applied spray-on bedliner
  - Bed-mounted 120-volt AC power outlet
  - Tailgate area illumination
- This package requires SV Value Truck Package. This package is not available on 4x4 models.

### P1 SV Premium Utility Package

- Power adjustable pedals
  - HomeLink<sup>®</sup> Universal Transceiver
  - Auto-dimming rearview mirror
  - Utili-track<sup>®</sup> Channel System with four tie-down cleats
  - Factory-applied spray-on bedliner
  - Bed-mounted 120-volt AC power outlet
  - Tailgate area illumination
  - Front tow hooks (SV 4x2)
  - Lower final gear ratio
  - Heavy-duty battery (standard on FFV models)
  - Power heated extendable tow mirrors
- This package requires SV Value Truck Package. This package is not available on King Cab<sup>®</sup> 4x4 models.

<sup>1</sup>Required SiriusXM<sup>®</sup> Satellite Radio, SiriusXM<sup>®</sup> Traffic and SiriusXM<sup>®</sup> Travel Link<sup>®</sup> services subscriptions sold separately and are continuous until you call SiriusXM to cancel. Installation costs, one-time activation fee, other fees and taxes will apply. SiriusXM Travel Link services available in select markets. Satellite Radio U.S. service, SiriusXM<sup>®</sup> Traffic and SiriusXM<sup>®</sup> Travel Link Services<sup>®</sup> available only to those 18 or older in the 48 contiguous states and D.C. Fees and programming subject to change. Subscriptions governed by Customer Agreement available at [siriusxm.com](http://siriusxm.com). ©2014 Sirius XM Radio Inc. Sirius<sup>®</sup> XM<sup>®</sup> and all related marks and logos are trademarks of Sirius XM Radio Inc. <sup>2</sup>Availability of specific features is dependent upon the phone's Bluetooth<sup>®</sup> support. Please refer to your phone Owner's Manual for details. Bluetooth<sup>®</sup> word mark and logos are owned by Bluetooth SIG, Inc., and any use of such marks by Nissan is under license. <sup>3</sup>Never program while driving. GPS mapping may not be detailed in all areas or reflect current road status. <sup>4</sup>Driving is serious business. Only use NissanConnect<sup>SM</sup> services when safe to do so. Subscription Agreement required. Compatible smartphone required. Not all app features are available for all models. Some apps have late availability. May require dealer service visit or software upgrade to activate. Never program while driving. GPS mapping may not be detailed in all areas or reflect current road status. Cellular network not available in all areas. Cellular network, apps, and services, including Google<sup>®</sup> services, are provided by independent companies not within Nissan's control and may require subscription and owner consent to activate. Should provider terminate/restrict service, service may be terminated without notice or liability to Nissan and/or its agents. Nissan not responsible for any equipment or app replacement/upgrades, or associated costs, that may be required for continued operation. Terms and conditions of Subscription Agreement apply. 36-month trial period starts on vehicle sale date; subsequently a paid subscription is required at the then current rate (excludes Pandora<sup>®</sup>). Standard text rates and/or data usage may apply. See retailer and check [www.NissanUSA.com/connect](http://www.NissanUSA.com/connect) for details. HomeLink<sup>®</sup> is a registered trademark of Johnson Controls Technology Company. iPod<sup>®</sup> is a registered trademark of Apple, Inc. All rights reserved. iPod<sup>®</sup> not included. Rockford Fosgate<sup>®</sup> is a registered trademark of Rockford Corporation.

## PACKAGES (CONTINUED)

### **P2** PRO-4X® Premium Utility Package

Nissan Navigation System with 5.8" color touch-screen monitor and Voice Recognition<sup>1</sup>  
 ▪ NissanConnect<sup>SM</sup> with Mobile Apps<sup>2</sup> ▪ SiriusXM® Traffic and Travel Link<sup>®3</sup> ▪ Streaming audio via Bluetooth® wireless technology<sup>4</sup> ▪ Rockford Fosgate®-powered AM/FM/CD audio system plus two speakers ▪ Power adjustable pedals ▪ HomeLink® Universal Transceiver  
 ▪ Extended overhead center console ▪ Utili-track® Channel System with four tie-down cleats  
 ▪ Factory-applied spray-on bedliner ▪ Bed-mounted 120-volt AC power outlet ▪ Tailgate area illumination ▪ Power heated extendable tow mirrors

### **L** PRO-4X® Luxury Package

4-way power adjustable passenger's seat ▪ Embroidered PRO-4X® leather-appointed seats with white stitching ▪ Heated front seats ▪ Memory System – driver's seat, pedals and outside mirrors ▪ In-cabin microfilter (Crew Cab only)

This package requires PRO-4X® Premium Utility Package.

### **MU** SL Max Utility Package

Front tow hooks (4x2 only) ▪ Heavy-duty battery (standard on FFV models) ▪ Lower final gear ratio ▪ Power heated extendable tow mirrors

### **D** DVD Package (PRO-4X® and SL Crew Cab)

Nissan Mobile Entertainment System with 8" flip-down monitor ▪ DVD player with auxiliary inputs, remote control and two wireless headsets

This package requires PRO-4X® Luxury Package on PRO-4X® models and SL Max Utility Package on SL models.

### **M** Moonroof Package (PRO-4X® and SL Crew Cab)

Power sliding glass moonroof

This package requires PRO-4X® Luxury Package on PRO-4X® models and SL Max Utility Package on SL models.

### **HM** Heavy Metal Edition® (SV and SL Crew Cab)

18" Chrome-clad alloy wheels (SV) ▪ 20" Chrome alloy wheels (SL) ▪ Chrome outside mirrors and door handles (SV only – standard on SL) ▪ Chrome billet grille ▪ Chrome step rails (SV only – standard on SL) ▪ Heavy Metal Edition® fender badging

SV Crew Cab requires SV Value Truck Package. Not available with SV Utility Package or SV Premium Utility Package.

## DIMENSIONS/CAPACITIES/WEIGHTS/MPG

Dimensions		
Exterior – Inches	King Cab	Crew Cab
Wheelbase	139.8	139.8
Overall length	224.6	224.6
Overall width	79.5	79.5
Overall height	Up to 76.6	Up to 76.9
Track Width – 18" Wheels	67.9	67.9
Track Width – 20" Wheels	68.1	68.1
Bed length	79.1 (6'7")	67.3 (5'7")
Bed width	63.8	63.8
Bed depth	19.9	19.9

Vehicle clearance	PRO-4X King Cab	PRO-4X Crew Cab
Minimum ground clearance at rear axle	10.7"	10.7"
Minimum ground clearance with skid plates	11.3"	11.3"
Angle of approach with skid plate	28.°	28.1°
Angle of departure	27.7°	27.8°
Break-over angle	21.4°	21.8°

Interior – Inches (front/rear)	King Cab	Crew Cab
Head room	41.0/38.9	41.0 <sup>5</sup> /40.4
Leg room	41.8/33.0	41.8/40.4
Hip room	61.3/60.3	61.3/60.5
Shoulder room	65.1/64.9	5.1/64.6
Interior passenger volume (cu. ft.)	112.8	125.6

Capacities		
	King Cab	Crew Cab
Seating capacity		
_With front bench seat	6	6
_With front captain's chairs	5	5
Fuel tank (gals.)	28.0	28.0
Engine oil (qts.)	7.0	7.0

Maximum Payload – Lbs. <sup>6</sup>		
Exterior – Inches	King Cab	Crew Cab
4x2	2,153	2,015
4x4	2,016	1,900

Maximum Towing – Lbs.				
King Cab	S	SV	PRO-4X	SL
Without Premium Utility Package				
4x2	7,400	7,400	–	–
4x4	–	–	9,300	–
Without Premium Utility Package				
4x2	–	9,500	–	–
4x4	–	–	9,300	–

King Cab	S	SV	PRO-4X	SL
Without Premium Utility or Max Utility Package				
4x2	7,400	7,400	–	7,100
4x4	7,300	7,300	9,300	7,000
With Premium Utility or Max Utility Package				
4x2	–	9,400	–	9,200
4x4	–	9,300	9,300	9,100

### 2015 EPA Fuel Economy Estimates

City/highway/combined MPG	
4x2	13/18/15
4x4	12/17/14

Actual mileage may vary with driving conditions – use for comparison only.

### King Cab®



79.5"



224.6"



Up to 76.6"

### Crew Cab



79.5"



224.6"



Up to 76.9"

<sup>1</sup>Never program while driving. GPS mapping may not be detailed in all areas or reflect current road status. <sup>2</sup>Driving is serious business. Only use NissanConnect™ services when safe to do so. Subscription Agreement required. Compatible smartphone required. Not all app features are available for all models. Some apps have late availability. May require dealer service visit or software upgrade to activate. Never program while driving. GPS mapping may not be detailed in all areas or reflect current road status. Cellular network not available in all areas. Cellular network, apps, and services, including Google® services, are provided by independent companies not within Nissan's control and may require subscription and owner consent to activate. Should provider terminate/restrict service, service may be terminated without notice or liability to Nissan and/or its agents. Nissan not responsible for any equipment or app replacement/upgrades, or associated costs, that may be required for continued operation. Terms and conditions of Subscription Agreement apply. 36-month trial period starts on vehicle sale date; subsequently a paid subscription is required at the then current rate (excludes Pandora®). Standard text rates and/or data usage may apply. See retailer and check [www.NissanUSA.com/connect](http://www.NissanUSA.com/connect) for details. <sup>3</sup>Required SiriusXM® Satellite Radio, SiriusXM® Traffic and SiriusXM® Travel Link® services subscriptions sold separately and are continuous until you call SiriusXM to cancel. Installation costs, one-time activation fee, other fees and taxes will apply. SiriusXM Travel Link services available in select markets. Satellite Radio U.S. service, SiriusXM® Traffic and SiriusXM® Travel Link Services® available only to those 18 or older in the 48 contiguous states and D.C. Fees and programming subject to change. Subscriptions governed by Customer Agreement available at [siriusxm.com](http://siriusxm.com). ©2014 Sirius XM Radio Inc. Sirius® XM® and all related marks and logos are trademarks of Sirius XM Radio Inc. <sup>4</sup>Availability of specific features is dependent upon the phone's Bluetooth® support. Please refer to your phone Owner's Manual for details. Bluetooth® word mark and logos are owned by Bluetooth SIG, Inc., and any use of such marks by Nissan is under license. <sup>5</sup>39.7" with moonroof. <sup>6</sup>S base models. HomeLink® is a registered trademark of Johnson Controls Technology Company. Rockford Fosgate® is a registered trademark of Rockford Corporation.

## BUYING/OWNING



**Nissan Motor Acceptance Corporation.** Whether you're buying or leasing, you'll find attractive rates and flexible terms to make your purchase more accessible.

**College Grad Program.** Ask about our special new vehicle pricing available to individuals up to two years after graduation.

**Active and Reserve US Military Program.** Ask about eligibility for our fixed discount on new vehicle pricing available to those serving our country.

**New Vehicle Limited Warranties.** Protection for your new Nissan includes 3-year/36,000-mile (whichever occurs first) basic coverage and 5-year/60,000-mile (whichever occurs first) powertrain coverage. Terms, conditions and exclusions apply. See Warranty Information Booklet for complete details.

**Security+Plus®** For additional peace of mind, a variety of extended service plans lets you tailor the coverage to your driving habits.

**Maintenance+Plus®** This extended plan ensures your Nissan will receive up to 17 different services and over 33 different inspection items at each visit, using the most up-to-date diagnostic equipment available.

**Genuine Nissan Parts.** When it comes time for service, any necessary replacement parts will be made using Genuine Nissan new or remanufactured parts, or Nissan-approved parts. And they're the only parts to carry Nissan's factory-backed limited warranty.

**Nissan Mobility Assist.** This program offers reimbursements toward the purchase and installation of certain mobility assistance products for program-eligible Nissans. Go to [NissanUSA.com/mobility](http://NissanUSA.com/mobility) for more info.

Nissan's environmental action plan focuses on several key areas. Increasing production of Zero Emission vehicles, including the 100% electric LEAF.® Improving fuel efficiency through our PUREDRIVE™ measures. And reducing the environmental impact of manufacturing, as seen at our new, energy-efficient, low-emissions paint plant in Tennessee. For more information, log on to [NissanUSA.com/green](http://NissanUSA.com/green)



Follow us:  @NissanSupport

At [NissanUSA.com](http://NissanUSA.com), you'll find virtual product demonstrations, a way to "build your own Nissan," a dealer locator, and more information about key Nissan support services. Or if you'd prefer, call **1-800-NISSAN-3** for answers to specific questions about Titan® or any other Nissan vehicle. The Nissan names, logos, product names, feature names, and slogans are trademarks owned by or licensed to Nissan Motor Co. Ltd. and/or its North American subsidiaries. **Tread Lightly!®** Please. Always wear your seat belt, and please don't drink and drive. ©2014 Nissan North America, Inc.

This brochure is intended for general descriptive and informational purposes only. It is subject to change and does not constitute an offer, representation or warranty (express or implied) by Nissan North America, Inc. Interested parties should confirm the accuracy of any information in this brochure as it relates to a vehicle directly with Nissan North America, Inc., before relying on it to make a purchase decision. Nissan North America, Inc., reserves the right to make changes, at any time, without prior notice, in prices, colors, materials, equipment, specifications, and models and to discontinue models or equipment. Due to continuous product development and other pre- and post-production factors, actual vehicle, materials and specifications may vary from this brochure. Some vehicles shown with optional equipment. See the actual vehicle for complete accuracy. Availability and delivery times for particular models or equipment may vary. Specifications, options and accessories may differ in Hawaii, U.S. territories and other countries. For additional information on availability, options or accessories, see your Nissan dealer or contact Nissan North America, Inc.



Sign up for the latest news and updates on the 2015 Nissan Titan.®

or visit [NissanUSA.com/titan](http://NissanUSA.com/titan)

Los folletos de Nissan también están disponibles en español.

Para descargar el PDF, visita:

[NissanUSA.com/folletos-espanol](http://NissanUSA.com/folletos-espanol)

And follow Nissan on:

