

1972 Monte Carlo

America's most attainable luxury car.



Chevrolet

1972 Monte Carlo
We left well enough alone...
to keep it alone in its field.



Beautifully quiet. Quietly beautiful. Monte Carlo has become one of the country's unprecedented luxury cars. Something we weren't about to change.

Standard power steering. Standard power front disc brakes. Standard 350-cubic-inch V8 engine. With the ride and comfort of the big luxury car.

No car but Monte Carlo weds all this to the agile 116-inch wheelbase and 5-ft. track of the sporty car.

The few cars that try bring you prices many hundreds of dollars higher.

Monte Carlo. America's most attainable luxury car. Still the only car in its field.



Many extra-cost Options and Custom Features may be ordered for Monte Carlo. Some are illustrated or described in this catalog.

Copyright 1971, Chevrolet Motor Division, General Motors Corporation.



Inside. It's where you'll spend much of your time. And where we spent much of ours.

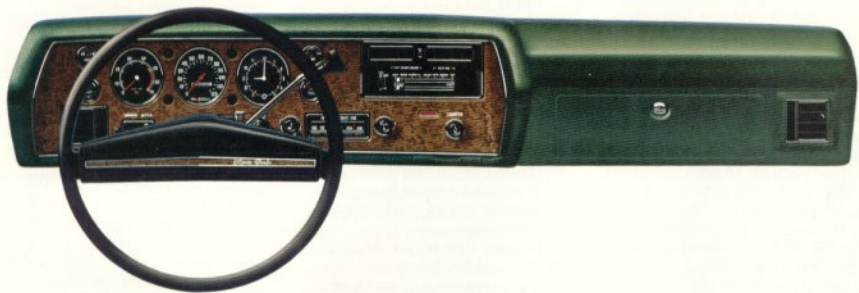

The exterior lines of Monte Carlo are clean and noticeably uncluttered. Inside, you'll find the same. Simplicity and tranquility.

Think of the seats as something Scandinavian. Tasteful, functional, never unnecessarily ornate.

The seats are designed like a good mattress. They leave you feeling comfortable and refreshed, whether you sit in them six minutes, or six hours. Springs and molded foam cushioning are carefully designed to support your back's natural weaknesses.

All you'll find on the door is one armrest, one door and window handle, above which is a highly functional assist strap. At the bottom, where the carpet climbs the door, is a map pocket. A nice touch, that.

Think of the instrument panel as something European. Where gauges and controls are highly accessible to both hand and eye. The wood grain pattern is Carpathian burl elm, specifically chosen to complement Monte Carlo's interior color choices. Which are many and varied.

The standard upholstery, shown at left, is obtainable in five cloth and vinyl combinations. Colors are black, green, blue, pewter or covert. A little extra money buys all-vinyl in black, covert or saddle.

Pictured below are our deep Strato-bucket seats. They're available with luxury cloth seating areas in black or pewter. All-vinyl choices come in black, green or saddle.

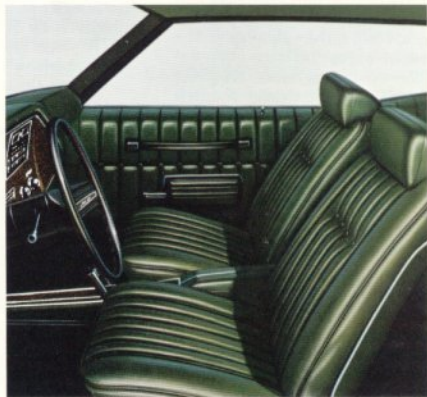

Read all about it!

Monte Carlo tends to be the most often misunderstood Chevrolet ever.

The problem is, there is no other car quite like a Monte Carlo. There's nothing to compare it to, no convenient category to put it in.

So some people will continue to assume Monte Carlo is an oversized sporty car putting on airs.

While others will remain convinced it's an undersized luxury car with a jealous eye cast toward the performance-minded.

Rest assured, Monte Carlo is neither. And perhaps both. Try thinking of it this way.

Monte Carlo combines the best (but not all) virtues of the luxury car with the best (but not all) virtues of the sporty car.

Owning a Monte Carlo is kind of like having your cake and driving it too.

Sorry, no power ashtrays.

Monte Carlo is a luxury car, yes. But without a big luxury car price. And there's one big reason why.

Little things.

We avoided imposing on you items which, for reasons of personal taste, you'd rather not have. Or have to pay for.

So we stuck to basics. We gave Monte Carlo the necessary luxuries. The ones luxury car buyers refuse to do without.

So look for things on the base Monte Carlo like power steering, power disc brakes, responsive 350-cu.-in. V8 engine.

Expect the quiet, tasteful interiors you saw on the previous pages . . . the kind that result from controlled use of fabrics and sound-deadening materials.

Have confidence that details have been attended to, that necessities like full wheel covers and electric clock are included as standard.

But if you *do* want, say, power door locks, content yourself that you can have them. Along with anything else you may wish to order from the list on page 10.

With Monte Carlo, we left little to chance. But assumed you'd like a choice.

Sorry, no four-on-the-floor.

True, Monte Carlo has an uncanny way of tracking and cornering.

But don't expect all the cliché trappings of the sports car. You can't get them on a Monte Carlo.

You can't get a Monte Carlo with racing stripes.

We don't offer a 4-speed floorbox.

No special hood scoops or louvers.

Monte Carlo isn't that kind of car. It's a luxury car. A luxury car built for handling. For those who truly like to drive.

And when it comes to handling in a luxury car, there are no substitutes for Monte Carlo's lighter weight (3359 lbs.).

Or wheelbase (116 inches).

Or front tire tread (60.3 inches).

Or coil-spring suspension.

You may perhaps doubt the credibility of a luxury car that dares speak of performance.

However, keep in mind, the makers of Monte Carlo also build a car called Camaro.

And a little two-seat thing called Corvette.

Perfectionists at work.

It might interest you to know, a Monte Carlo is inspected scores of times before it ever leaves the plant.

Our inspectors check the innumerable body spot welds that produce in Monte Carlo an uncommonly strong unit.

They examine the "coach joints"—the welds—that give Monte Carlo a custom-built look.

They put it through simulated rainstorms to test the total watertight capability of the car.

Then the steering gets inspected. The brakes, alignment, electrical system, transmission, everything of vital concern is carefully scrutinized.

Should something not check out satisfactorily, the car is pulled aside and the problem corrected. Immediately.



In about 4 minutes.

You won't settle for less than the best. And neither will we.

Some vital statistics

Wheelbase	116 in.
Length	206.5 in.
Width	75.6 in.
Height	52.9 in.
Front tread	60.3 in.
Rear tread	59.3 in.
Turning radius	.42 ft.
Curb weight	3359 lbs.
Usable luggage space	12.9 cu. ft.
Fuel tank capacity	19 gal.

Engines and Transmissions.

Over 10 years ago, we promised to get Chevrolet cars out of the air pollution picture.

Every year since has seen improvements. And 1972 is no exception.

Every Monte Carlo will have exhaust emission control systems for continued reduction of carbon monoxide and hydrocarbon emissions.

And, of course, all engines are designed to run quite efficiently on all regular fuels including the latest no-lead or low-lead gasolines.

There are four engines from which to select:

165-hp Turbo-Fire 350 V8 (Standard)

175-hp Turbo-Fire 350 V8

240-hp Turbo-Jet 400 V8

270-hp Turbo-Jet 454 V8

And, depending on which engine you select, there are three transmissions:

3-Speed manual (Standard)

Powerglide

Turbo Hydra-matic

The standard engine can be ordered with any transmission.

The other three engines are available only with the Turbo Hydra-matic transmission.

Monte Carlo Turbo-Jet engines are not available in California.

About horsepower ratings. Those above, in accordance with Society of Automotive Engineers standards, represent the power output of engines as installed in the automobile.

Safety (and security) first.

The American driver is becoming more and more concerned with subjects like safety and security.

So, following is a list of some of the major features incorporated in every '72 Monte Carlo.

We hope you'll never have need of these items. But we think you'll drive more comfortably just knowing that they're there.

Occupant Protection Features

Three-point seat and shoulder belt system for driver and right front passenger features reminder light and buzzer • Self-adjusting and locking retractors for all outboard belt positions • Two front seat head restraints • Energy-absorbing steering column • Passenger guard door locks with forward-mounted lock buttons • Safety door latches and hinges • Folding seat back latches • Energy-absorbing instrument panel and front seat back tops • Contoured windshield header • Thick-laminate windshield • Padded sun visors • Safety armrests • Safety steering wheel • Side-guard beams • Cargo-guard luggage compartment.

Accident Prevention Features

Side marker lights and reflectors (front side marker lenses flash with direction signal) • Parking lights that illuminate with headlights • Four-way hazard warning flasher • Backup lights • Lane-change feature in direction signal control • Windshield defroster, washers and dual-speed wipers • Wide-view inside day-night mirror (vinyl-edged, shatter-resistant glass and deflecting support) • Outside rearview mirror • Dual master cylinder brake system with warning light • Starter safety switch • Dual-action safety hood latches.

Anti-theft Features

Anti-theft ignition key warning buzzer • Anti-theft steering column lock • Multiple key combinations • Visible vehicle identification • Tamper-resistant odometer with telltale feature.



Beauty is more than

That the 1972 Monte Carlo is a beautiful car is obvious. But there is more to beauty than looks alone. Not so obvious are some of the standard features that make Monte Carlo more than just another pretty face.

1. Standard Turbo-Fire V8 designed to run on all regular grade fuels including low-lead or no-lead gasolines.
2. Standard power disc/drum brake system features discs in front; finned brake drums in rear for rapid heat dissipation. Dual master cylinder system with warning light, too.
3. Standard variable-ratio power steering is especially valuable when parking in cramped places. The more you have to turn the steering wheel, the quicker the front wheels turn.
4. Deep coil springs are individually tailored to car and equipment weight.
5. Delco Eye battery has sealed side terminals to help prevent corrosion buildup, plus the "magic eye" that signals for a fluid refill.
6. Seat construction consists of the flat S springs found in fine furniture, covered with foam cushioning and rich upholstery.
7. Rugged inner fenders positioned at each wheel help protect outer fenders from salt, water, tar, stones, and the like.
8. Magic-Mirror acrylic lacquer finish; superior to enamel in many ways. It's tougher, less porous. Which makes it harder to stain, easier to restore.
9. Steering column lock operates under the principle that it's difficult to steal what you can't steer. Just remove ignition key and steering wheel locks.
10. Cargo-guard luggage barrier is a steel bulkhead

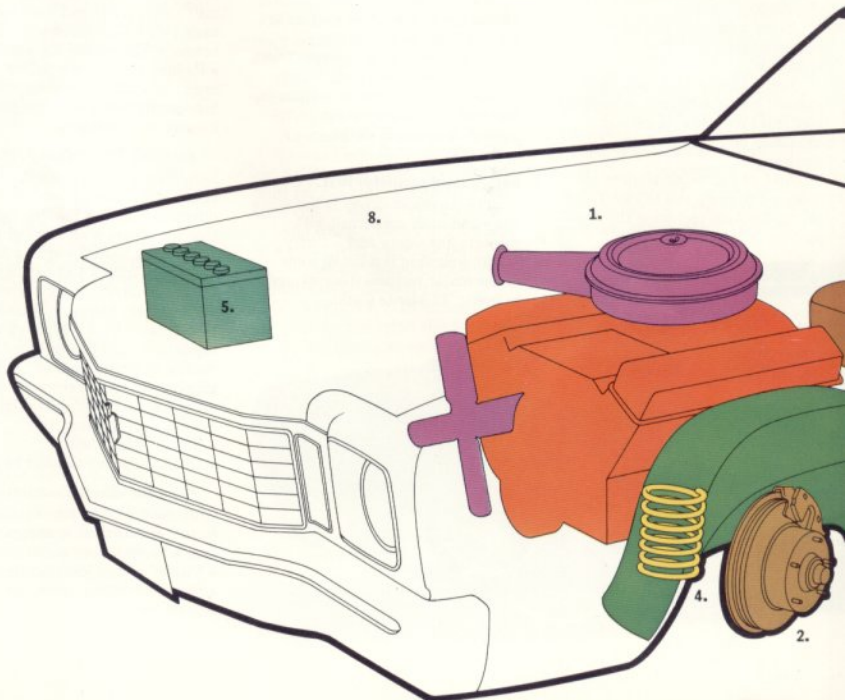

sheet-metal deep.

- between back seat and trunk.
11. Long-life exhaust system is aluminized in critical areas to help prevent destructive rust.
 12. Advanced body mounting system involves positioning thick rubber cushions at strategic points where body and frame meet to help minimize road noise and vibration.
 13. Flush-and-dry rocker panels are constructed so that rain or wash water flushes out dirt; then they dry themselves as you drive.
 14. Side-guard beams are built into the doors for added protection.
 15. Standard full wheel covers.
 16. Large-size G78 x 15 bias belted ply tires

contribute toward improved handling, traction and stopping. Tire and wheel units are factory balanced for longer tire life and quieter operation.

Other features include:

Special engine cushioning made of strong vibration-absorbent butyl rubber helps isolate power team impulses from frame and body.

Full door glass eliminates ventipane. Less clutter and wind noise. No need for ventipanes with Astro Ventilation, which delivers a silent stream of new air replacing old as you drive.

Hidden antenna built into windshield glass with any factory-installed radio.

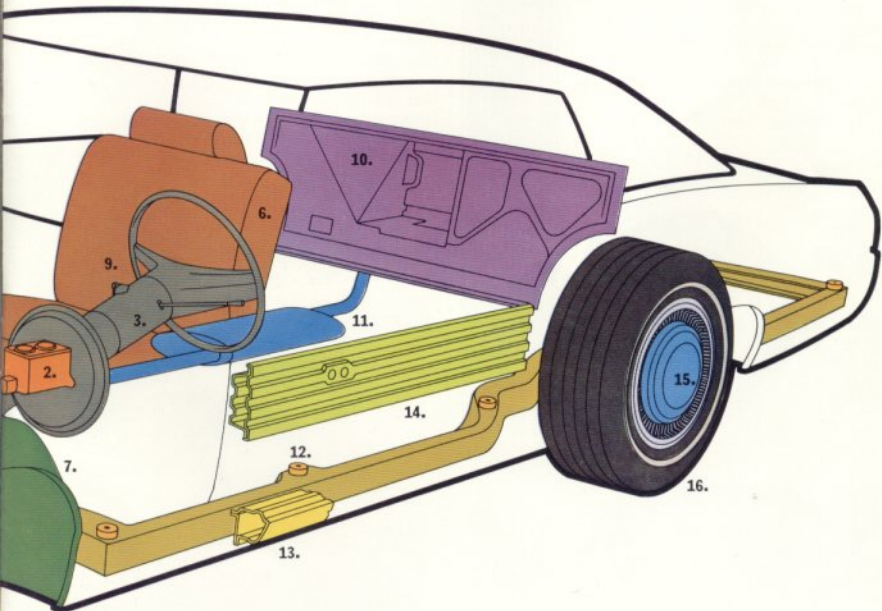

If you want more

Like we've been telling you, the 1972 Monte Carlo is pretty much the complete luxury car. You get a lot as standard equipment. But if you want more, look over

- Engines and transmissions (page 7).
- Power windows—pushbutton convenience for driver and passengers (fig. F).
- Power seat—four different positions for bench or bucket seat.
- Power door lock system—for convenient instant locking (fig. E).
- Rear-window defroster (fig. H).
- Remote-control outside mirror.
- Air conditioning (fig. C).
- Tinted glass.
- Center console—with bucket seats only (fig. A).
- Deluxe wheel covers.
- Custom wheel covers (fig. B).
- Sport steering wheel.
- Comfortilt steering wheel (six positions).

the list below. Feel free to order whatever you wish.

The first thing to consider is the Monte Carlo Custom option. It's a package that includes Custom

- Rally wheels—center hub, exposed chrome nuts and chrome ring.
- Cruise-Master speed control—maintains desired speed until you touch the brake pedal.
- Rear fender skirts (fig. D).
- "Wet look" vinyl roof cover—comes in black, white, tan, covert or green.
- Radios: AM; AM/FM; AM/FM/Stereo.
- Stereo tape system with AM or AM/FM/Stereo radio (fig. G).
- Rear-seat speaker.
- Custom seat belts.
- Superlift shock absorbers (with Automatic Level Control).
- Belt or body side moldings.
- Heavy-duty battery, radiator, generator.
- Appearance Guard Group: bumper and door edge guards, mats and vanity mirror.

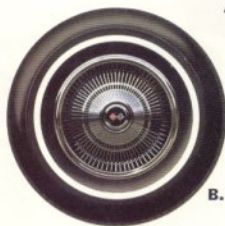
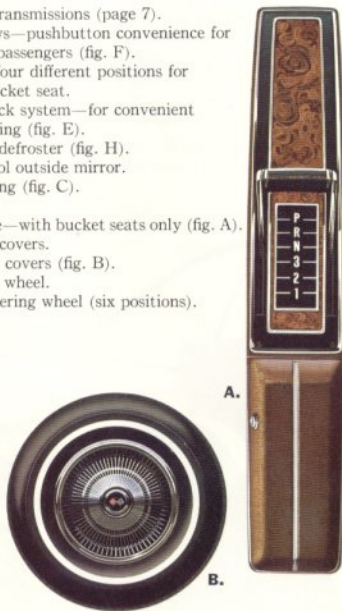

C.

D.

H.

it's all here.

wheel covers, Custom steering wheel, extra soundproofing, Sport suspension, big G70 x 15 tires, 15 x 7" wheels, remote-control mirror, belt

molding, and special convenience lighting. The Monte Carlo below is wearing the Custom package, along with other items mentioned at left.





We want your Monte Carlo to be the best car you ever owned. And we want it to be the easiest car you've ever ordered. So, to save yourself a little time, just check the items below. For specifics, consult pages 7 and 10.

Exterior colors

- Mulsanne Blue, Midnight Bronze, Ascot Blue,
- Golden Brown, Mohave Gold, Placer Gold,
- Gulf Green, Sequoia Green, Spring Green,
- Orange Flame, Cranberry Red, Pewter Silver,
- Covert Tan, Antique White, Cream Yellow.

Interior and colors

Conventional seat: cloth and vinyl in black, green, blue, pewter, covert; all-vinyl is available in black, covert, saddle.

Strato-bucket seats (extra cost): cloth and vinyl in black, pewter; all-vinyl in black, green, saddle.

Engines and Transmissions

- 165-hp Turbo-Fire 350 V8 (standard)
- 175-hp Turbo-Fire 350 V8
- 240-hp Turbo-Jet 400 V8
- 270-hp Turbo-Jet 454 V8
- 3-Speed fully synchronized manual (standard)
- Powerglide Automatic
- Turbo Hydra-matic

Popular Options

- Monte Carlo Custom package
- Four-Season air conditioning
- Radios: AM; AM/FM; AM/FM/Stereo
- Stereo tape system with AM or AM/FM/Stereo radio
- Four-way power seat
- Power door locks
- Deluxe wheel covers
- Custom wheel covers
- Rally wheels
- Sport steering wheel
- Custom steering wheel
- Comfortilt steering wheel
- Rear fender skirts
- Cruise-Master speed control
- Center console (with buckets and extra-cost transmission only)
- Soft-Ray tinted glass
- Rear window defroster
- Vinyl roof cover (black, white, tan, covert, green)

All illustrations and specifications contained in this literature are based on the latest product information available at the time of publication approval. The right is reserved to make changes at any time without notice, in prices, colors, materials, equipment, specifications and models, and to discontinue models. Chevrolet Motor Division, General Motors Corporation, Detroit, Mich. 48202. Litho in U.S.A.

Chevrolet

Building a better way to see the USA.

